

Product Image

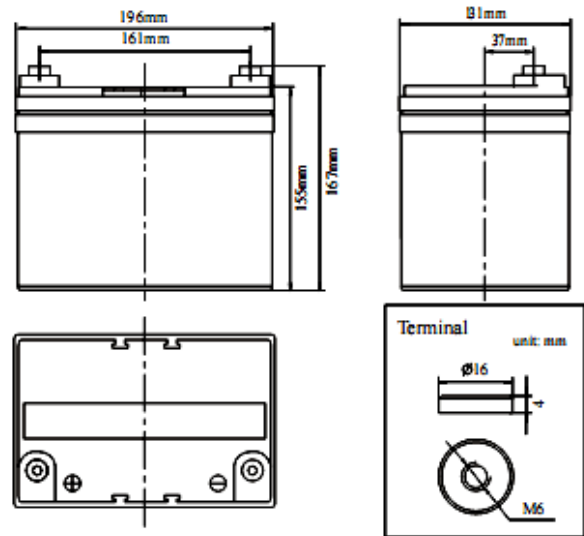

Product Dimensions



Characteristics

Nominal Voltage		12V
Watts/cell@15min		145W
Capacity 25°C (77°F)	10 hour rate (3.4A)	34Ah
	5 hour rate (6.2A)	31Ah
	1 hour rate (22.8A)	22.8Ah
Internal Resistance	Full Charged Battery 25°C	≤9.5m Ω
Capacity affected by Temperature (10 hour)	40°C (104°F)	102%
	25°C (77°F)	100%
	0°C (32°F)	85%
Self-Discharge 25°C (77°F) Capacity	after 3 month storage	90%
	after 6 month storage	80%
	after 12 month storage	62%
Charge (Constant Voltage) 25°C (77°F)	Float	Initial Charging Current Less than 6.8A Voltage 13.6-13.8V
	Cycle	Initial Charging Current Less than 6.8A Voltage 14.4-14.9V

Packaging

Battery Dimensions	Length	196mm
	Width	130mm
	Height	155mm
	Total Height	167mm
Box Dimensions	Length	211mm
	Width	144mm
	Height	211mm
Quantity Per Box		1 PC per box
Net weight Per Cell		11 kg±3%
Net weight Per Box		11kg
Gross Weight		11.3kg

Discharge Constant Power per Cell (Watts at 77°F25°C)

F.V/Time	5min	10min	15min	20min	25min	30min	45min	60min	90min	2h	3h	10h
1.60V	209.2	174.4	147.9	124.9	104.6	84.4	61.3	42.6	35.6	26.9	19.5	7.0
1.67V	205.4	171.2	145.0	123.3	102.7	82.8	60.2	41.8	35.0	26.5	19.2	6.8
1.70V	201.6	168.0	142.5	121.0	100.8	81.3	59.1	41.0	34.2	25.9	18.8	6.7
1.75V	197.8	164.9	139.8	117.2	98.9	79.8	58.0	40.3	33.6	25.4	18.5	6.6
1.80V	190.2	158.5	134.4	112.2	95.1	76.7	55.8	38.7	32.3	24.5	17.8	6.3

Discharge Constant Current per Cell (Amperes at 77°F 25°C)

F.V/Time	5min	10min	15min	20min	25min	30min	45min	60min	90min	2h	3h	10h
1.60V	112.2	93.5	79.3	67.0	56.1	45.3	32.9	22.8	19.1	14.5	10.5	3.74
1.67V	110.1	91.8	77.8	66.1	55.1	44.4	32.3	22.4	18.7	14.2	10.3	3.66
1.70V	108.1	90.1	76.4	64.9	54.1	43.6	31.7	22.0	18.4	13.9	10.1	3.61
1.75V	106.0	88.4	75.0	62.8	53.1	42.8	31.1	21.6	18.0	13.6	9.9	3.53
1.80V	102.0	85.0	72.1	60.2	51.0	41.1	29.9	20.7	17.3	13.1	9.5	3.40

Note The above data are average values, and can be obtained within 3 charge/discharge cycles. These are not minimum values. Cell and battery designs/specifications are subject to modification without notice. Contact **MCA** for the latest information.

Performance Characteristics

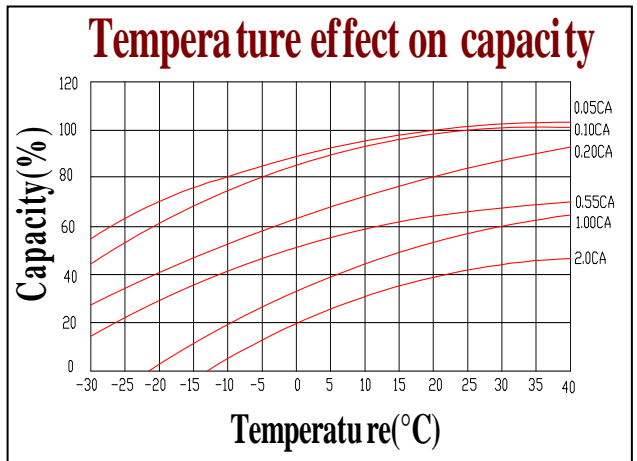
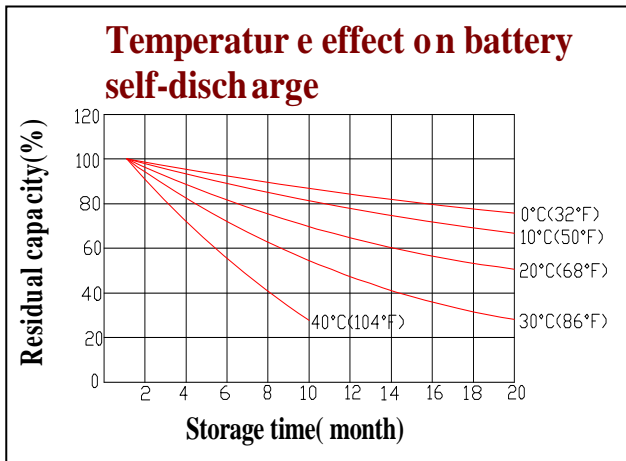
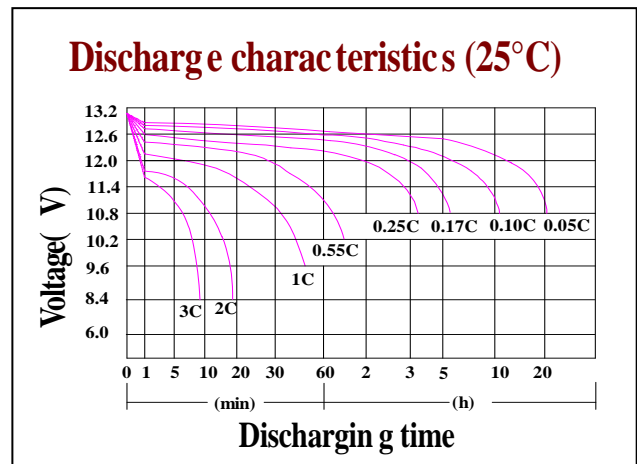
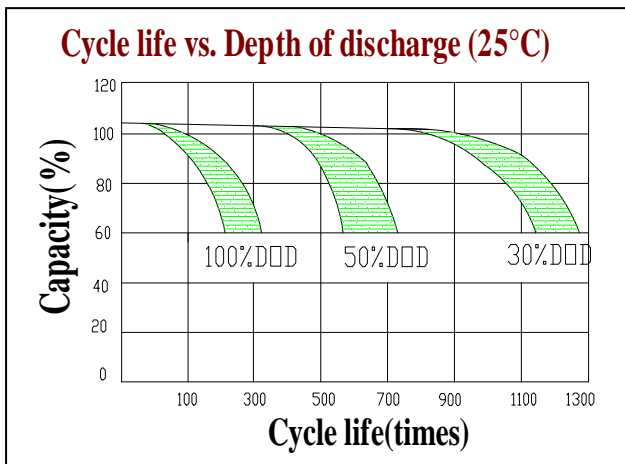
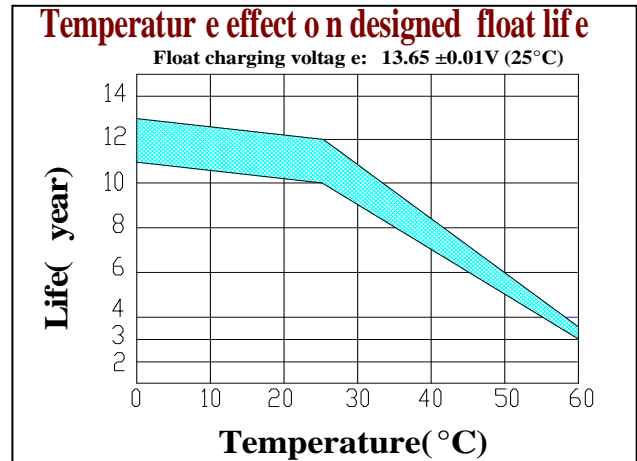
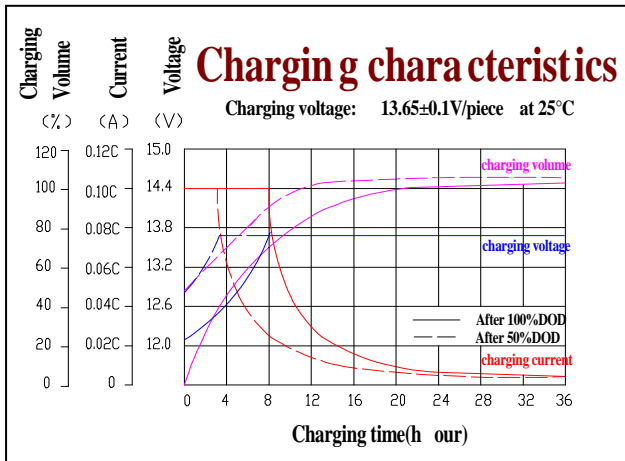

Battery Construction

Component	Positive plate	Negative plate	Container	Cover	Safety valve	Terminal	Separator	Electrolyte
Raw material	Lead dioxide	Lead	ABS	ABS	Si-Rubber	Copper	Fiberglass	Sulfuric acid