

Product Image

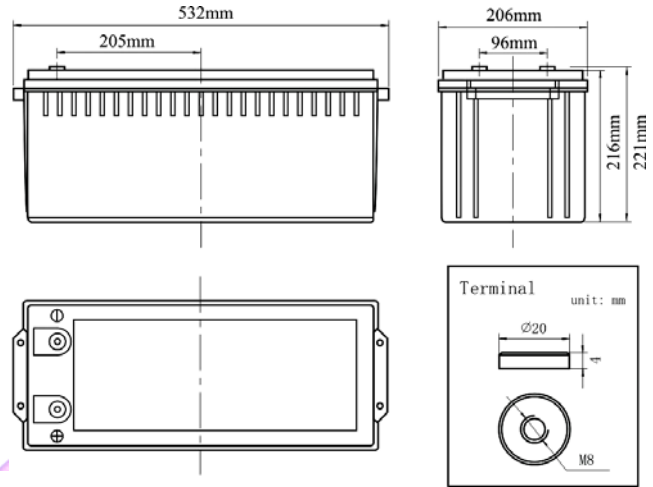

Product Dimensions



Characteristics

Nominal Voltage		12V
Watts/cell@15min		680W
Capacity 25°C (77°F)	10 hour rate (17.0A)	170Ah
	5 hour rate (31A)	155Ah
	1 hour rate (114.1A)	114.1Ah
Internal Resistance	Full Charged Battery 25°C	≤3.3m Ω
Capacity affected by Temperature (10 hour)	40°C (104°F)	102%
	25°C (77°F)	100%
	0°C (32°F)	85%
	-15°C (5°F)	65%
Self-Discharge 25°C (77°F) Capacity	after 3 month storage	90%
	after 6 month storage	80%
	after 12 month storage	62%
Charge (Constant Voltage) 25°C (77°F)	Float	Initial Charging Current Less than 34.0A Voltage 13.6-13.8V
	Cycle	Initial Charging Current Less than 34.0A Voltage 14.4-14.9V

Packaging

Battery Dimensions	Length	532mm
	Width	206mm
	Height	216mm
	Total Height	221mm
Box Dimensions	Length	547mm
	Width	220mm
	Height	296mm
Quantity Per Box		1 PC per box
Net weight Per Cell		58.5 kg±3%
Net weight Per Box		58.5kg
Gross Weight		59.2kg

Discharge Constant Power per Cell (Watts at 77°F 25°C)

F.V/Time	5min	10min	15min	20min	25min	30min	45min	60min	90min	2h	3h	10h
1.60V	1039.2	836.9	694.0	493.8	418.6	366.3	306.7	212.8	177.9	134.7	97.5	34.9
1.67V	1020.1	821.7	680.0	487.6	410.7	359.4	301.2	208.9	174.8	132.4	95.9	34.1
1.70V	1001.4	806.5	669.0	478.7	403.3	352.8	295.6	204.9	171.1	129.6	93.9	33.7
1.75V	982.3	791.3	656.3	463.5	395.8	346.3	290.1	201.3	168.0	127.2	92.3	32.9
1.80V	944.8	760.9	630.9	443.9	380.5	332.9	279.0	193.4	161.7	122.5	88.8	31.7

Discharge Constant Current per Cell (Amperes at 77°F 25°C)

F.V/Time	5min	10min	15min	20min	25min	30min	45min	60min	90min	2h	3h	10h
1.60V	557.2	448.8	372.1	264.8	224.4	196.4	164.5	114.1	95.4	72.3	52.3	18.7
1.67V	547.0	440.6	365.3	261.5	220.2	192.7	161.5	112.0	93.7	71.0	51.4	18.3
1.70V	536.9	432.5	358.7	256.7	216.2	189.2	158.5	109.9	91.8	69.5	50.4	18.1
1.75V	526.7	424.3	351.9	248.5	212.2	185.7	155.6	108.0	90.1	68.2	49.5	17.6
1.80V	506.6	408.0	338.3	238.0	204.0	178.5	149.6	103.7	86.7	65.7	47.6	17.0

Note The above data are average values, and can be obtained within 3 charge/discharge cycles. These are not minimum values. Cell and battery designs/specifications are subject to modification without notice. Contact **MCA** for the latest information.

Performance Characteristics

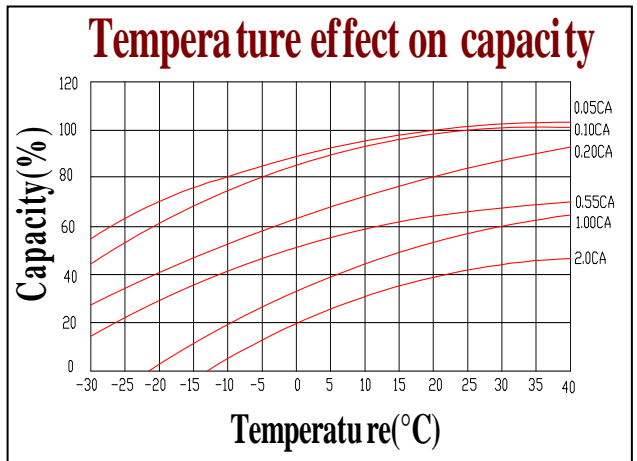
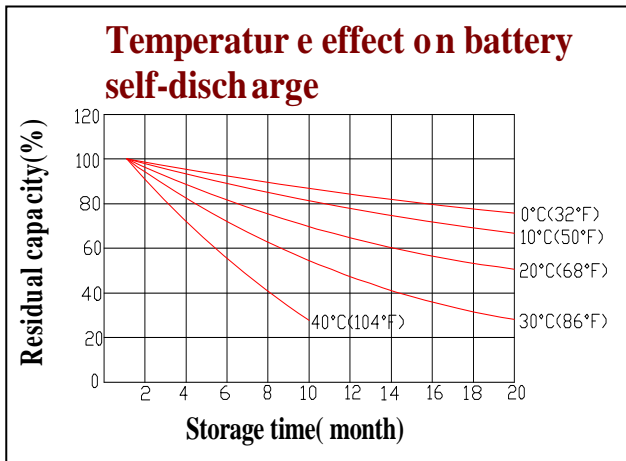
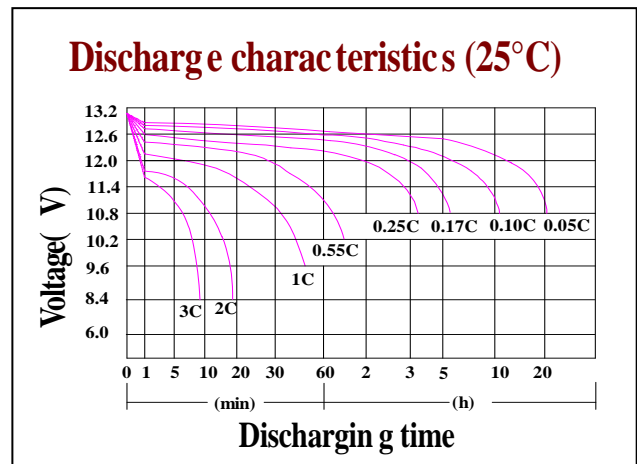
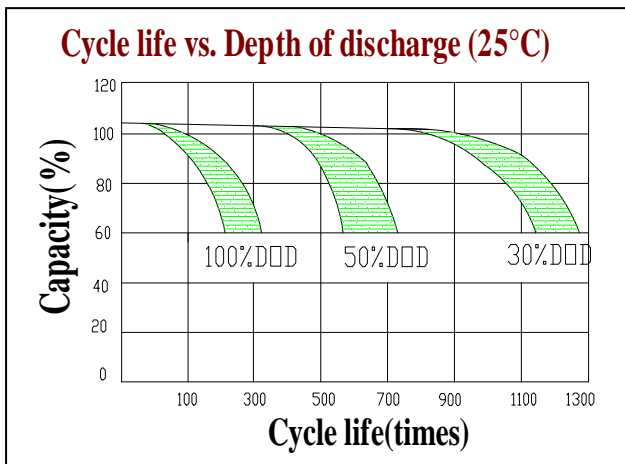
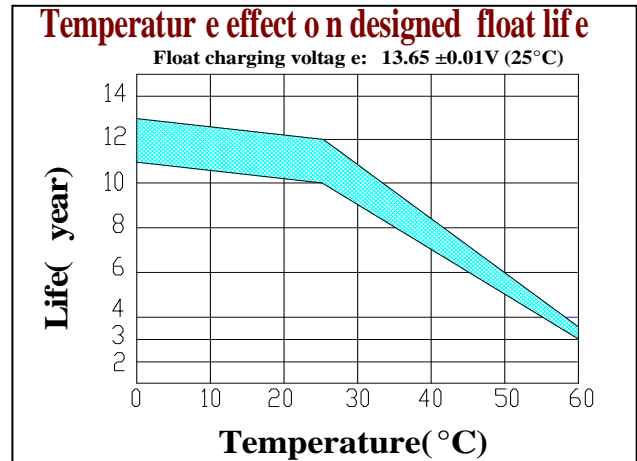
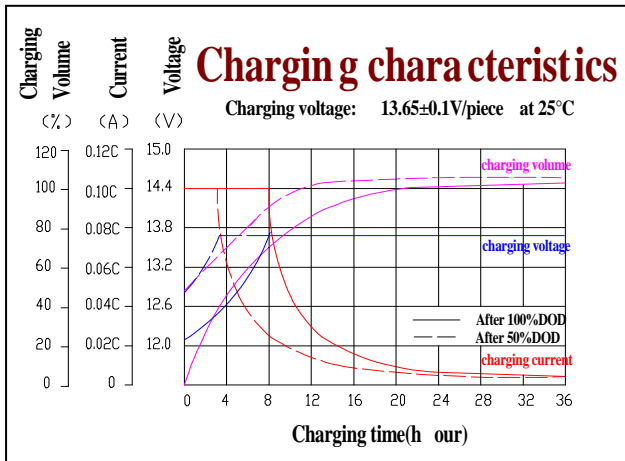

Battery Construction

Component	Positive plate	Negative plate	Container	Cover	Safety valve	Terminal	Separator	Electrolyte
Raw material	Lead dioxide	Lead	ABS	ABS	Si-Rubber	Copper	Fiberglass	Sulfuric acid