

Product Image

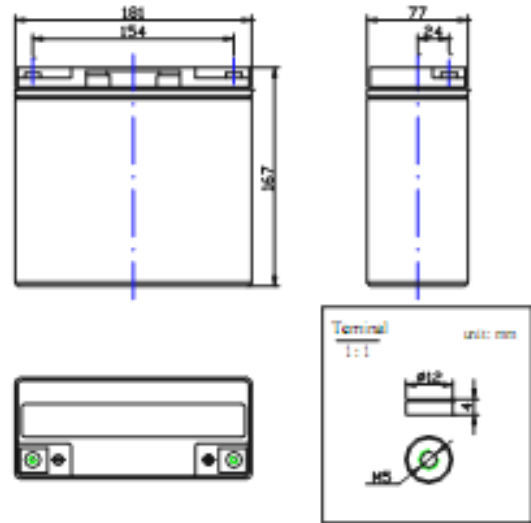

Product Dimensions



Characteristics

Nominal Voltage		12V
Watts/cell@15min		85W
Capacity 25°C (77°F)	10 hour rate (2.0A)	20Ah
	5 hour rate (3.7A)	17.5Ah
	1 hour rate (13.4A)	13.4Ah
Internal Resistance	Full Charged Battery 25°C	≤18m Ω
Capacity affected by Temperature (10 hour)	40°C (104°F)	102%
	25°C (77°F)	100%
	0°C (32°F)	85%
Self-Discharge 25°C (77°F) Capacity	after 3 month storage	90%
	after 6 month storage	80%
	after 12 month storage	62%
Charge (Constant Voltage) 25°C (77°F)	Float	Initial Charging Current Less than 6.0A Voltage 13.6-13.8V
	Cycle	Initial Charging Current Less than 6.0A Voltage 14.4-14.9V

Packaging

Battery Dimensions	Length	181mm
	Width	77mm
	Height	167mm
	Total Height	167mm
Box Dimensions	Length	341mm
	Width	195mm
	Height	213mm
Quantity Per Box		4 PC per box
Net weight Per Cell		6.5 kg±3%
Net weight Per Box		27.0kg
Gross Weight		27.5kg

Discharge Constant Power per Cell (Watts at 77°F 25°C)

F.V/Time	5min	10min	15min	20min	25min	30min	45min	60min	90min	2h	3h	10h
1.60V	123.1	102.6	86.6	73.4	61.6	49.7	36.1	25.0	20.9	15.9	11.5	4.1
1.67V	120.8	100.7	85.0	72.5	60.4	48.7	35.4	24.6	20.6	15.6	11.3	4.0
1.70V	118.6	98.8	83.5	71.2	59.3	47.8	34.8	24.1	20.1	15.2	11.1	4.0
1.75V	116.3	97.0	81.9	68.9	58.2	47.0	34.1	23.7	19.8	15.0	10.9	3.9
1.80V	111.9	93.3	78.7	66.0	56.0	45.1	32.8	22.8	19.0	14.4	10.4	3.7

Discharge Constant Current per Cell (Amperes at 77°F 25°C)

F.V/Time	5min	10min	15min	20min	25min	30min	45min	60min	90min	2h	3h	10h
1.60V	66.0	55.0	46.4	39.4	33.0	26.6	19.4	13.4	11.2	8.5	6.2	2.20
1.67V	64.8	54.0	45.6	38.9	32.4	26.1	19.0	13.2	11.0	8.4	6.1	2.15
1.70V	63.6	53.0	44.7	38.2	31.8	25.7	18.7	12.9	10.8	8.2	5.9	2.13
1.75V	62.4	52.0	43.9	37.0	31.2	25.2	18.3	12.7	10.6	8.0	5.8	2.08
1.80V	60.0	50.0	42.2	35.4	30.0	24.2	17.6	12.2	10.2	7.7	5.6	2.00

Note The above data are average values, and can be obtained within 3 charge/discharge cycles. These are not minimum values. Cell and battery designs/specifications are subject to modification without notice. Contact **MCA** for the latest information.

Performance Characteristics

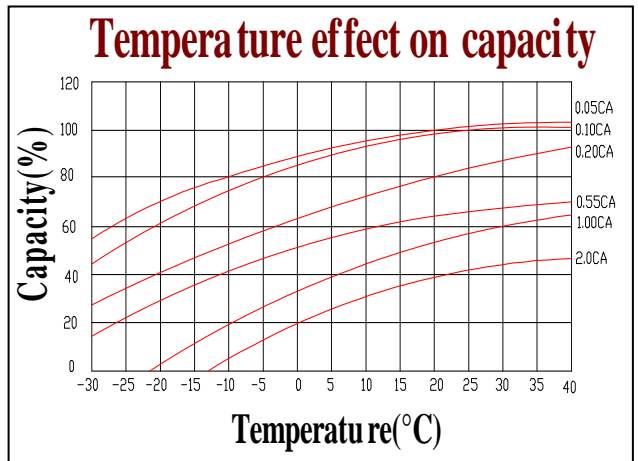
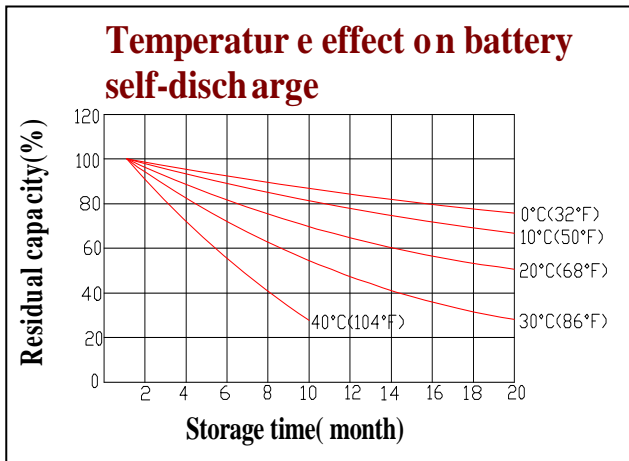
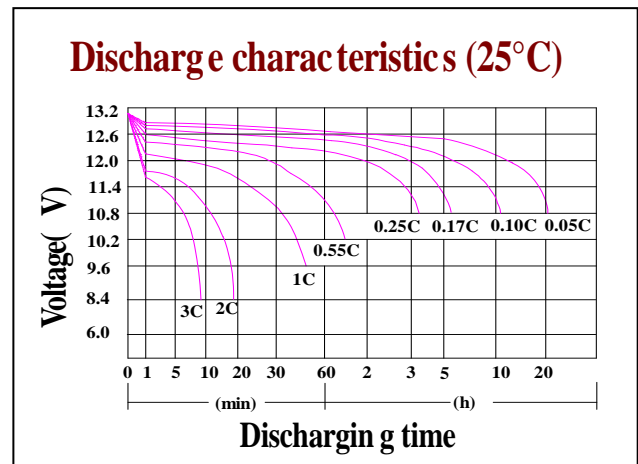
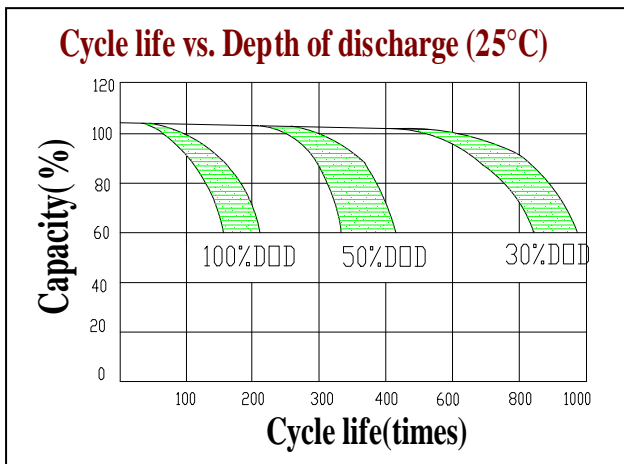
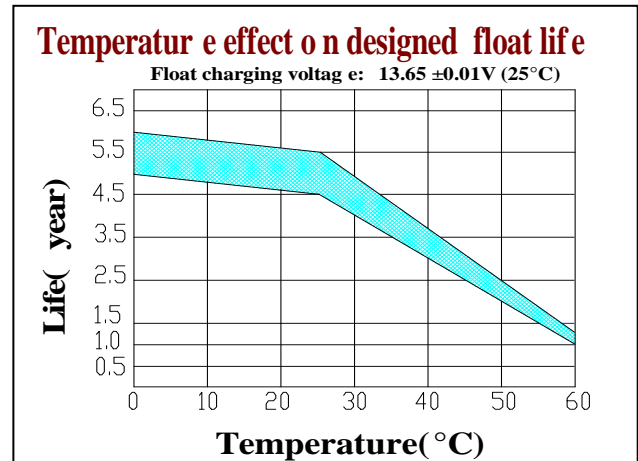
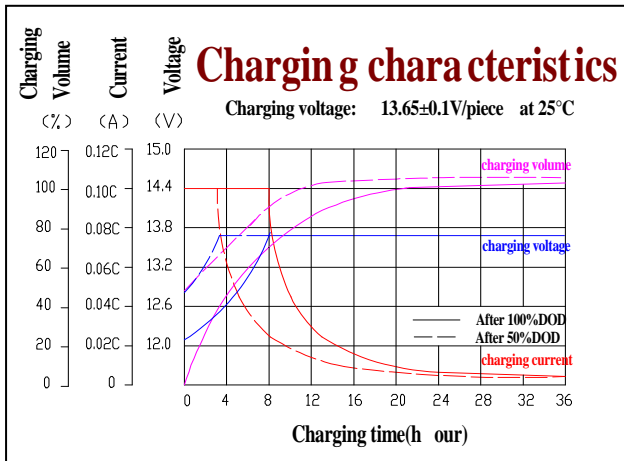

Battery Construction

Component	Positive plate	Negative plate	Container	Cover	Safety valve	Terminal	Separator	Electrolyte
Raw material	Lead dioxide	Lead	ABS	ABS	Si-Rubber	Copper	Fiberglass	Sulfuric acid