

Product Image

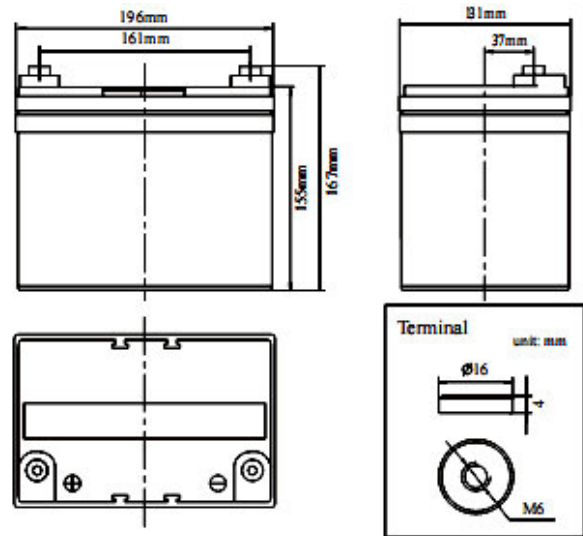

Product Dimensions



Characteristics

Nominal Voltage		12V
Nominal Capacity (10 hour rate)		33Ah
Capacity 25°C (77°F)	20 hour rate (1.83A)	36.6Ah
	5 hour rate (6.0A)	30.0Ah
	1 hour rate (20.0A)	20.0Ah
Internal Resistance	Full Charged Battery 25°C	≤11mΩ
Capacity affected by Temperature (10 hour)	40°C (104°F)	102%
	25°C (77°F)	100%
	0°C (32°F)	85%
	-15°C (5°F)	65%
Self-Discharge 25°C (77°F) Capacity	after 3 month storage	90%
	after 6 month storage	80%
	after 12 month storage	62%
Charge (Constant Voltage) 25°C (77°F)	Float	Initial Charging Current Less than 8.25A Voltage 13.6-13.8V
	Cycle	Initial Charging Current Less than 8.25A Voltage 14.4-14.9V

Packaging

Battery Dimensions	Length	196mm
	Width	130mm
	Height	155mm
	Total Height	167mm
Box Dimensions	Length	211mm
	Width	144mm
	Height	211mm
Quantity Per Box		1 PC per box
Net weight Per Cell		10 kg±100g
Net weight Per Box		10kg
Gross Weight		10.5kg

Discharge Constant Current per Cell (Amperes at 77°F 25°C)

F.V/Time	15min	30min	45min	1h	2h	3h	5h	8h	10h	20h
1.60V	55.7	31.5	22.6	20.0	13.4	9.8	6.3	3.8	3.4	1.82
1.65V	53.4	30.6	22.0	19.4	13.1	9.6	6.2	3.8	3.4	1.80
1.70V	51.1	29.8	21.4	18.9	12.9	9.4	6.1	3.8	3.4	1.78
1.75V	48.8	29.0	20.8	18.4	12.6	9.2	6.0	3.7	3.3	1.77
1.80V	46.4	28.1	20.2	17.8	12.3	9.0	5.9	3.7	3.3	1.75

Discharge Constant Power per Cell (Watts at 77°F 25°C)

F.V/Time	15min	30min	45min	1h	2h	3h	5h	8h	10h	20h
1.60V	103.9	58.7	42.1	37.2	25.0	18.2	11.7	7.2	6.4	3.4
1.65V	99.6	57.2	41.0	36.2	24.5	17.9	11.6	7.1	6.3	3.4
1.70V	95.3	55.6	39.9	35.2	24.0	17.6	11.4	7.0	6.3	3.3
1.75V	90.9	54.0	38.7	34.2	23.5	17.2	11.2	7.0	6.2	3.3
1.80V	86.6	52.4	37.6	33.2	22.9	16.7	11.1	6.9	6.2	3.3

Note The above data are average values, and can be obtained within 3 charge/discharge cycles. These are not minimum values. Cell and battery designs/specifications are subject to modification without notice. Contact **MCA** for the latest information.

Performance Characteristics

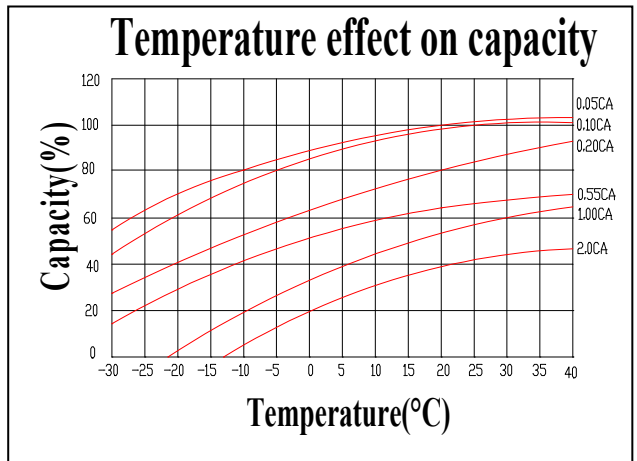
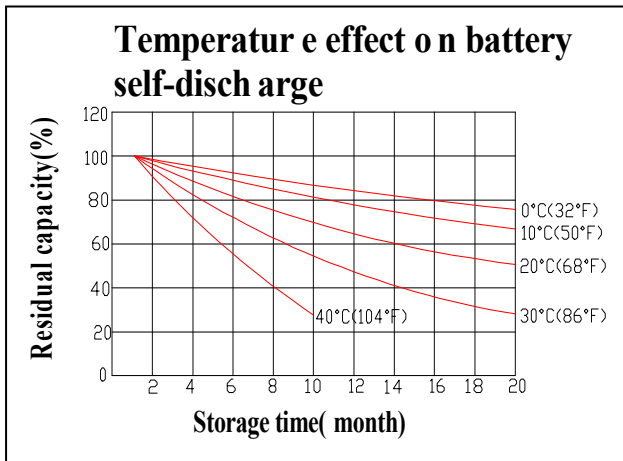
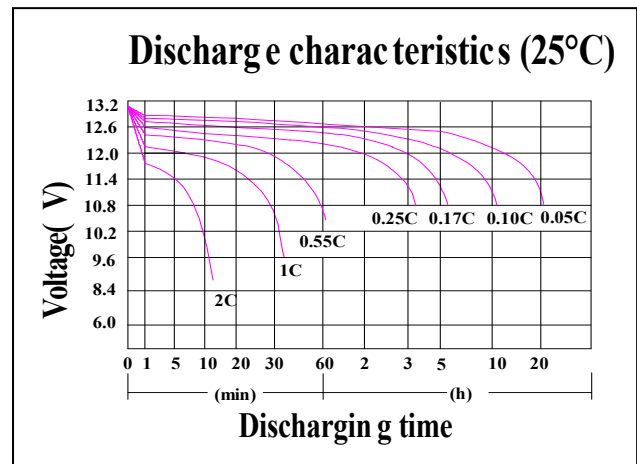
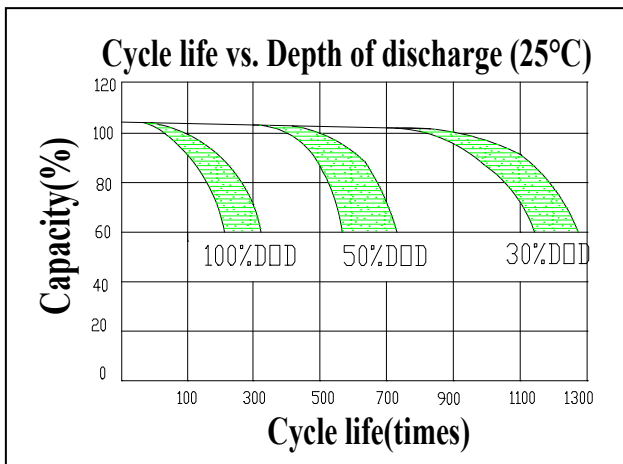
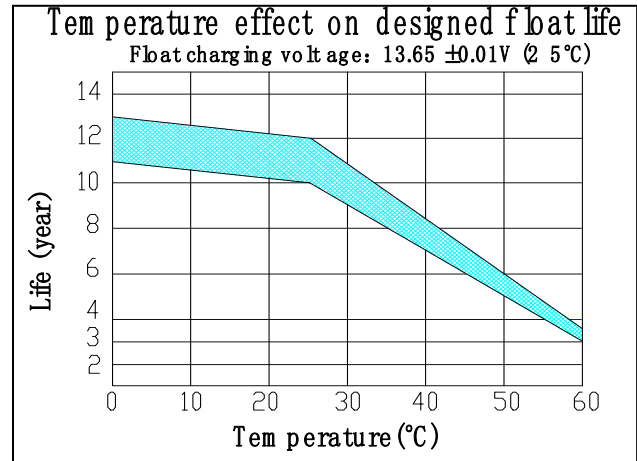
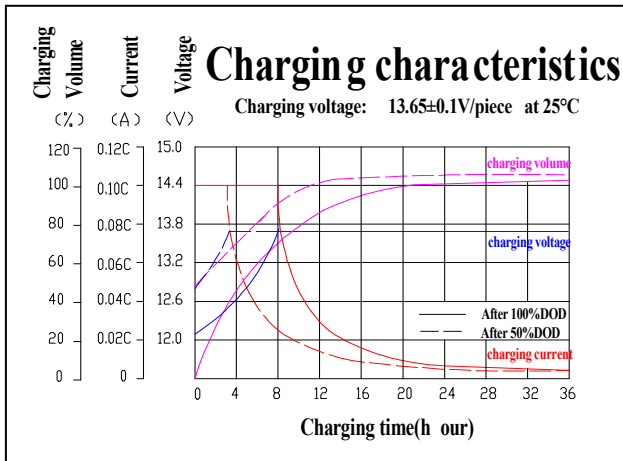

Battery Construction

Component	Positive plate	Negative plate	Container	Cover	Safety valve	Terminal	Separator	Electrolyte
Raw material	Lead dioxide	Lead	ABS	ABS	Si-Rubber	Copper	Fiberglass	Sulfuric acid