

Product Image

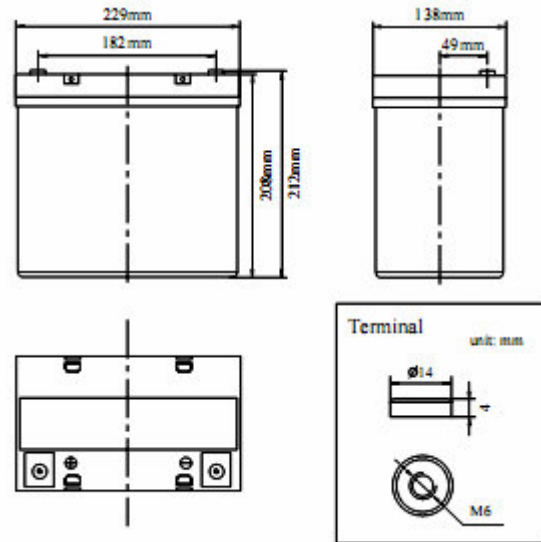

Product Dimensions



Characteristics

Nominal Voltage		12V
Nominal Capacity (10 hour rate)		55Ah
Capacity 25°C (77°F)	20 hour rate (3.05A)	61.0Ah
	5 hour rate (10.0A)	50Ah
	1 hour rate (36.6A)	36.6Ah
Internal Resistance	Full Charged Battery 25°C	≤8.2mΩ
Capacity affected by Temperature (10 hour)	40°C (104°F)	102%
	25°C (77°F)	100%
	0°C (32°F)	85%
	-15°C (5°F)	65%
Self-Discharge 25°C (77°F) Capacity	after 3 month storage	90%
	after 6 month storage	80%
	after 12 month storage	62%
Charge (Constant Voltage) 25°C (77°F)	Float	Initial Charging Current Less than 13.8A Voltage 13.6-13.8V
	Cycle	Initial Charging Current Less than 13.8A Voltage 14.4-14.9V

Packaging

Battery Dimensions	Length	229mm
	Width	138mm
	Height	208mm
	Total Height	212mm
Box Dimensions	Length	244mm
	Width	152mm
	Height	254mm
Quantity Per Box		1 PC per box
Net weight Per Cell		17.2 kg±3%
Net weight Per Box		17.2kg
Gross Weight		17.6kg

Discharge Constant Current per Cell (Amperes at 77°F 25°C)

F.V/Time	15min	30min	45min	1h	2h	3h	5h	8h	10h	20h
1.60V	92.9	57.8	41.5	36.6	22.3	16.3	10.5	6.4	5.72	3.17
1.65V	89.0	56.2	40.3	35.6	21.9	16.0	10.3	6.3	5.67	3.14
1.70V	85.1	54.7	39.2	34.6	21.5	15.7	10.2	6.3	5.61	3.11
1.75V	81.3	53.1	38.1	33.7	21.0	15.3	10.0	6.2	5.56	3.08
1.80V	77.4	51.6	37.0	32.7	20.5	15.0	9.9	6.2	5.50	3.05

Discharge Constant Power per Cell (Watts at 77°F 25°C)

F.V/Time	15min	30min	45min	1h	2h	3h	5h	8h	10h	20h
1.60V	173.2	107.8	77.3	68.2	41.6	30.4	19.6	11.9	10.7	5.9
1.65V	166.0	104.9	75.2	66.4	40.8	29.9	19.3	11.8	10.6	5.9
1.70V	158.8	102.0	73.2	64.6	40.1	29.3	19.0	11.7	10.5	5.8
1.75V	151.5	99.1	71.1	62.8	39.1	28.6	18.7	11.6	10.4	5.7
1.80V	144.3	96.2	69.0	60.9	38.2	27.9	18.5	11.5	10.3	5.7

Note The above data are average values, and can be obtained within 3 charge/discharge cycles. These are not minimum values. Cell and battery designs/specifications are subject to modification without notice. Contact **MCA** for the latest information.

Performance Characteristics

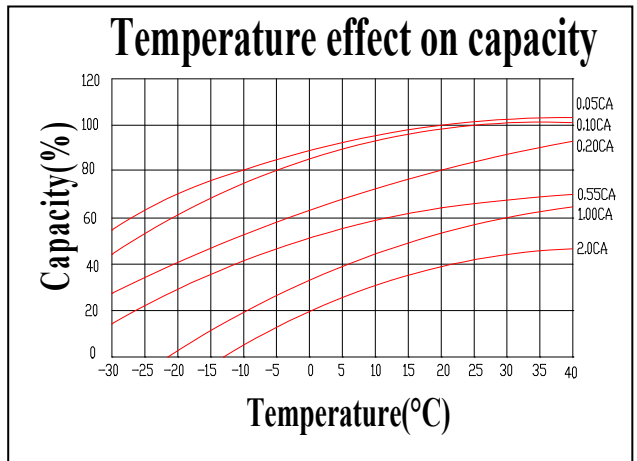
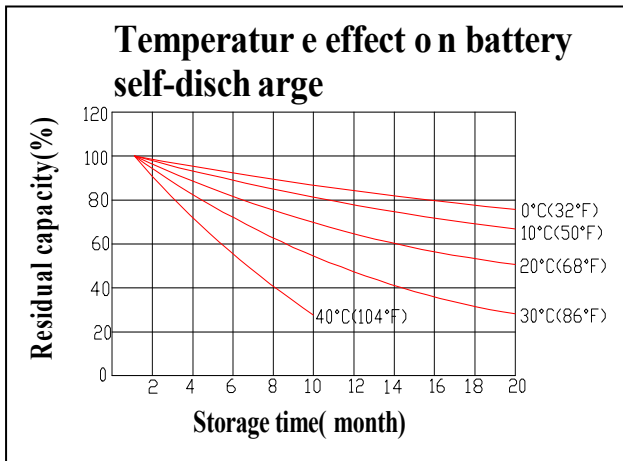
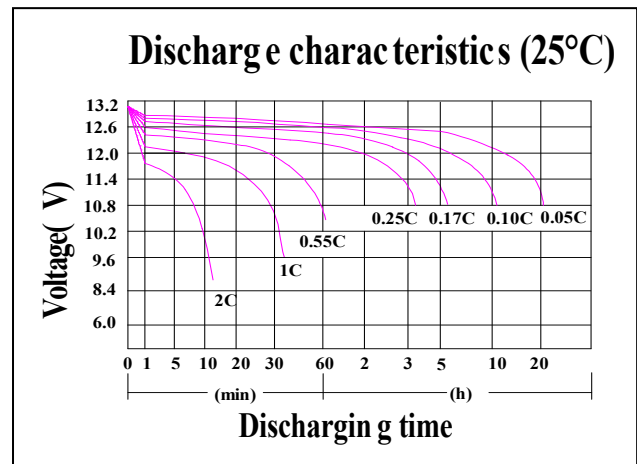
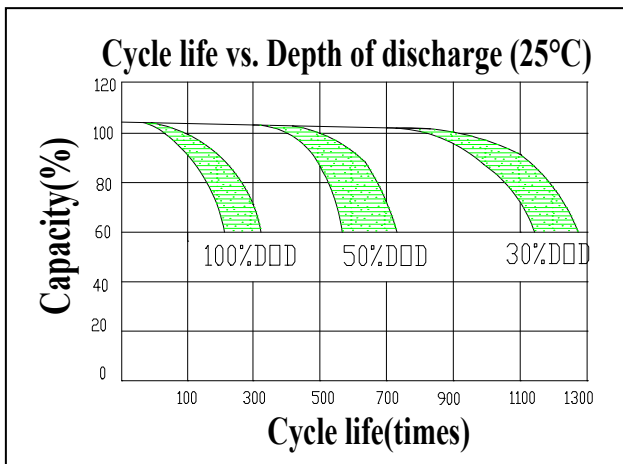
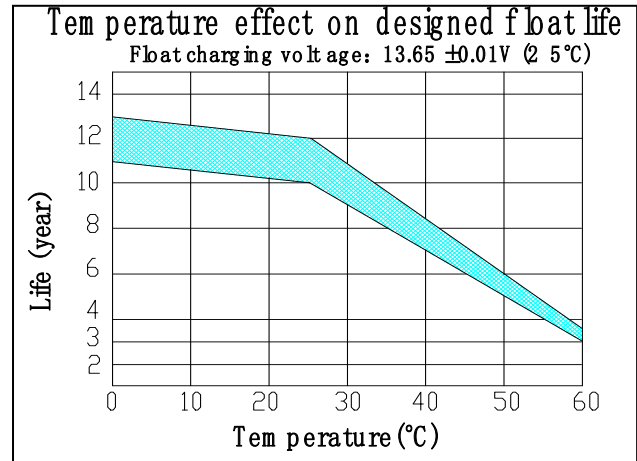
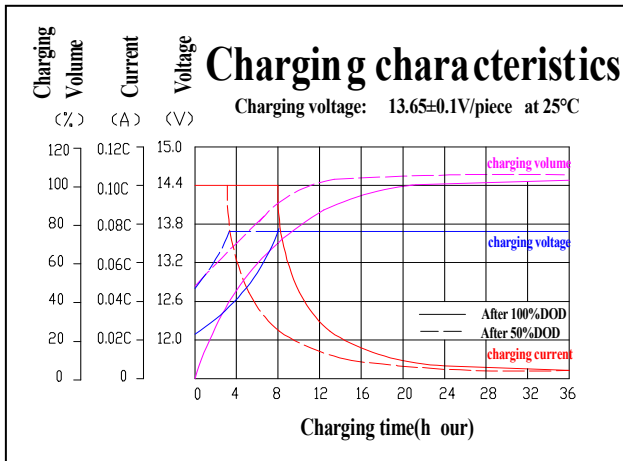

Battery Construction

Component	Positive plate	Negative plate	Container	Cover	Safety valve	Terminal	Separator	Electrolyte
Raw material	Lead dioxide	Lead	ABS	ABS	Si-Rubber	Copper	Fiberglass	Sulfuric acid