

Product Image

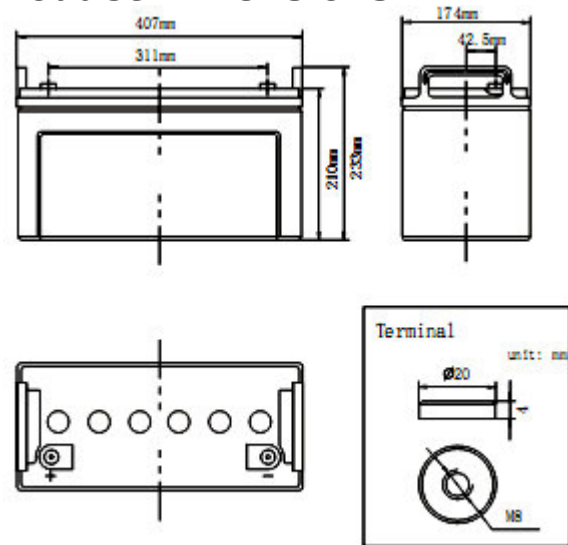

Product Dimensions



Characteristics

Nominal Voltage		12V
Nominal Capacity (10 hour rate)		95Ah
Capacity 25°C (77°F)	20 hour rate (5.04A)	100.8Ah
	5 hour rate (17.4A)	87.0Ah
	1 hour rate (57.5A)	57.5Ah
Internal Resistance	Full Charged Battery 25°C	≤6.5mΩ
Capacity affected by Temperature (10 hour)	40°C (104°F)	102%
	25°C (77°F)	100%
	0°C (32°F)	85%
Self-Discharge 25°C (77°F) Capacity	after 3 month storage	90%
	after 6 month storage	80%
	after 12 month storage	62%
Charge (Constant Voltage) 25°C (77°F)	Float	Initial Charging Current Less than 19A Voltage 13.6-13.8V
	Cycle	Initial Charging Current Less than 19A Voltage 14.4-14.9V

Packaging

Battery Dimensions	Length	407mm
	Width	174mm
	Height	210mm
	Total Height	233mm
Box Dimensions	Length	422mm
	Width	188mm
	Height	290mm
Quantity Per Box		1 PC per box
Net weight Per Cell		29.5kg±3%
Net weight Per Box		29.5kg
Gross Weight		30.0kg

Discharge Constant Current per Cell (Amperes at 77°F 25°C)

F.V/Time	15min	30min	45min	1h	2h	3h	5h	8h	10h	20h
1.60V	160.4	90.7	65.0	57.5	38.5	28.2	18.1	11.1	9.9	5.24
1.65V	153.7	88.2	63.3	55.9	37.8	27.6	17.9	11.0	9.8	5.19
1.70V	147.0	85.8	61.5	54.4	37.1	27.1	17.6	10.9	9.7	5.14
1.75V	140.3	83.4	59.8	52.8	36.2	26.5	17.4	10.7	9.6	5.09
1.80V	133.7	80.9	58.0	51.3	35.3	25.8	17.1	10.6	9.5	5.04

Discharge Constant Power per Cell (Watts at 77°F 25°C)

F.V/Time	15min	30min	45min	1h	2h	3h	5h	8h	10h	20h
1.60V	308.8	174.5	125.1	110.6	74.2	54.2	34.9	21.3	19.0	10.1
1.65V	295.9	169.8	121.8	107.6	72.8	53.2	34.4	21.1	18.8	10.0
1.70V	283.0	165.2	118.4	104.7	71.4	52.2	33.9	20.9	18.7	9.9
1.75V	270.2	160.5	115.1	101.7	69.7	51.0	33.4	20.7	18.5	9.8
1.80V	257.3	155.8	111.7	98.8	68.0	49.7	32.9	20.5	18.3	9.7

Note The above data are average values, and can be obtained within 3 charge/discharge cycles. These are not minimum values. Cell and battery designs/specifications are subject to modification without notice. Contact **MCA** for the latest information.

Performance Characteristics

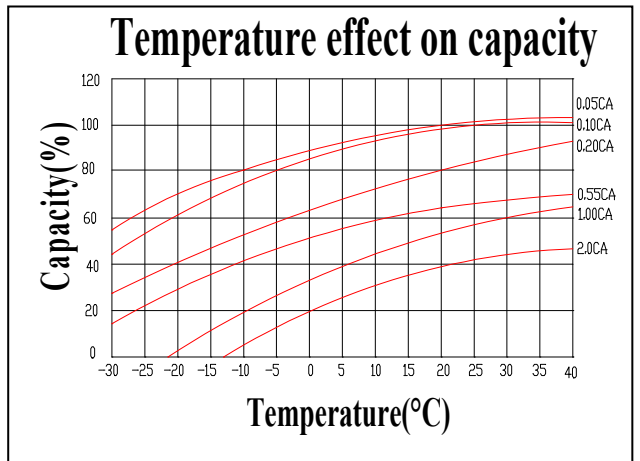
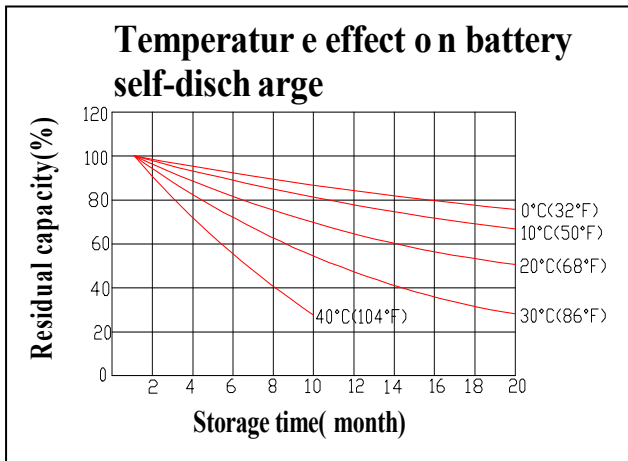
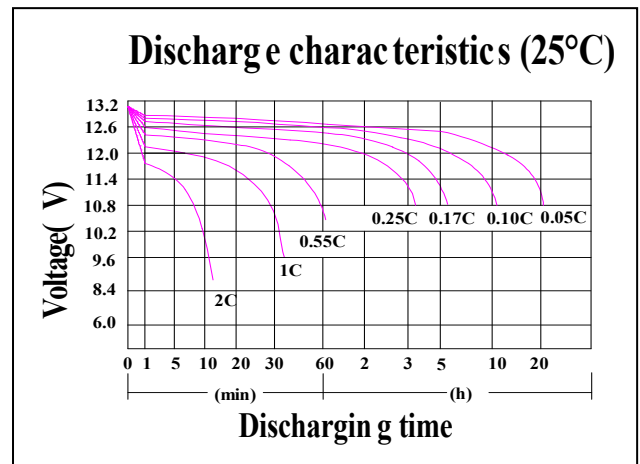
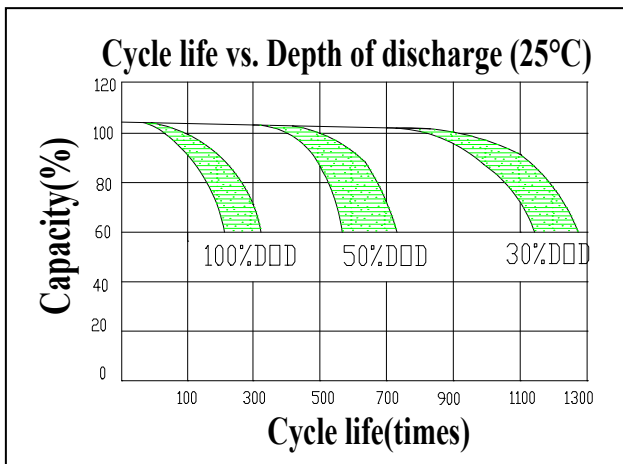
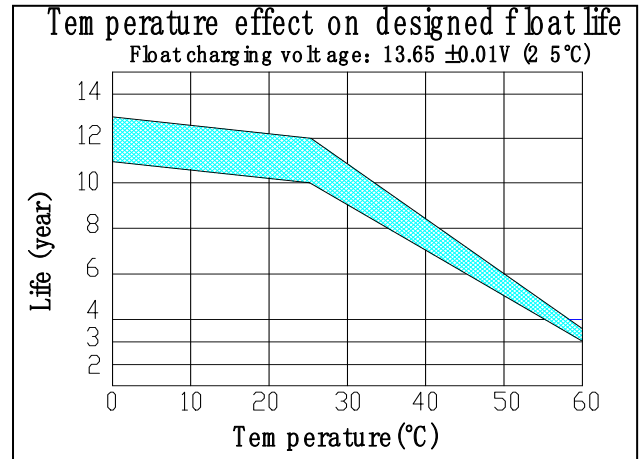
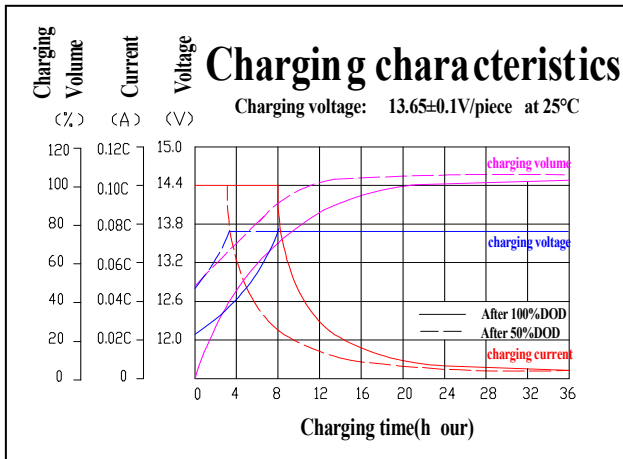

Battery Construction

Component	Positive plate	Negative plate	Container	Cover	Safety valve	Terminal	Separator	Electrolyte
Raw material	Lead dioxide	Lead	ABS	ABS	Si-Rubber	Copper	Fiberglass	Sulfuric acid