

Product Image

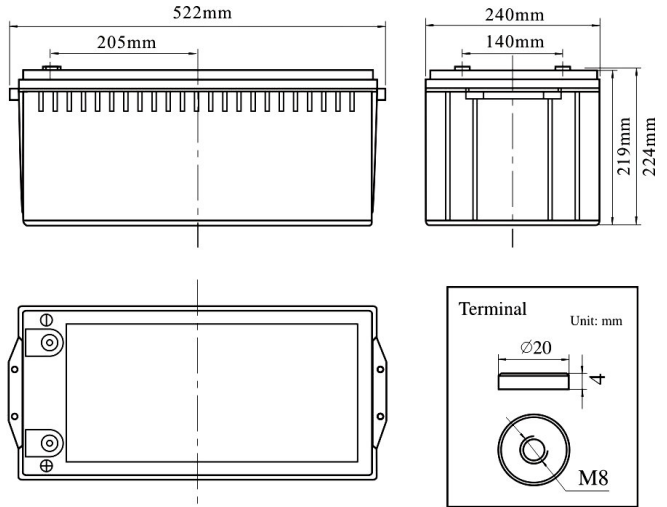

Product Dimensions



Characteristics

Nominal Voltage		12V
Nominal Capacity (10 hour rate)		220Ah
Capacity 25°C (77°F)	20 hour rate (12.1A)	242Ah
	5 hour rate (38.9A)	194.5Ah
	1 hour rate (142.8A)	142.8Ah
Internal Resistance	Full Charged Battery 25°C	≤2.1mΩ
Capacity affected by Temperature (10 hour)	40°C (104°F)	102%
	25°C (77°F)	100%
	0°C (32°F)	85%
	-15°C (5°F)	65%
Self-Discharge 25°C (77°F) Capacity	after 3 month storage	90%
	after 6 month storage	80%
	after 12 month storage	62%
Charge (Constant Voltage) 25°C (77°F)	Float	Initial Charging Current Less than 44A Voltage 13.6-13.8V
	Cycle	Initial Charging Current Less than 44A Voltage 14.4-14.9V

Packaging

Battery Dimensions	Length	520mm
	Width	269mm
	Height	203mm
	Total Height	209mm
Box Dimensions	Length	539mm
	Width	285mm
	Height	283mm
Quantity Per Box		1 PC per box
Net weight Per Cell		68 kg±3%
Net weight Per Box		68kg
Gross Weight		68.8kg

Discharge Constant Current per Cell (Amperes at 77°F 25°C)

F.V/Time	15min	30min	45min	1h	2h	3h	5h	8h	10h	20h
1.60V	317.0	223.9	160.7	142.8	88.3	60.5	41.1	27.1	24.2	13.3
1.65V	311.3	219.8	157.8	140.2	86.7	59.4	40.4	26.6	23.8	13.1
1.70V	305.5	215.7	154.8	137.6	85.1	58.3	39.6	26.1	23.3	12.8
1.75V	299.7	211.6	151.9	135.0	83.5	57.2	38.9	25.6	22.9	12.6
1.80V	288.2	203.5	146.1	129.8	80.3	55.0	37.4	24.6	22.0	12.1

Discharge Constant Power per Cell (Watts at 77°F 25°C)

F.V/Time	15min	30min	45min	1h	2h	3h	5h	8h	10h	20h
1.60V	610.3	430.9	309.3	274.9	170.0	116.5	79.2	52.2	46.6	25.6
1.65V	599.2	423.1	303.7	269.9	166.9	114.3	77.8	51.2	45.7	25.2
1.70V	588.1	415.2	298.1	264.9	163.9	112.2	76.3	50.3	44.9	24.7
1.75V	577.0	407.4	292.5	259.9	160.8	110.1	74.9	49.3	44.0	24.2
1.80V	554.8	391.7	281.2	249.9	154.6	105.9	72.0	47.4	42.4	23.3

Note The above data are average values, and can be obtained within 3 charge/discharge cycles. These are not minimum values. Cell and battery designs/specifications are subject to modification without notice. Contact **MCA** for the latest information.

Performance Characteristics

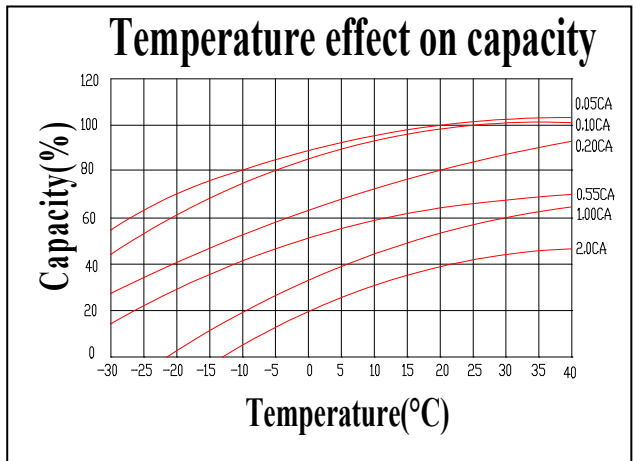
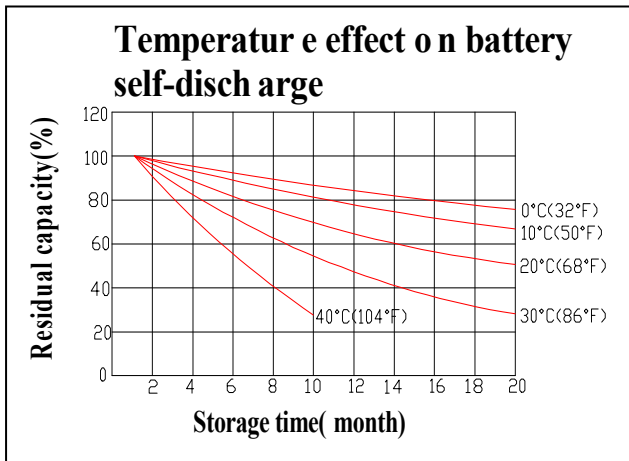
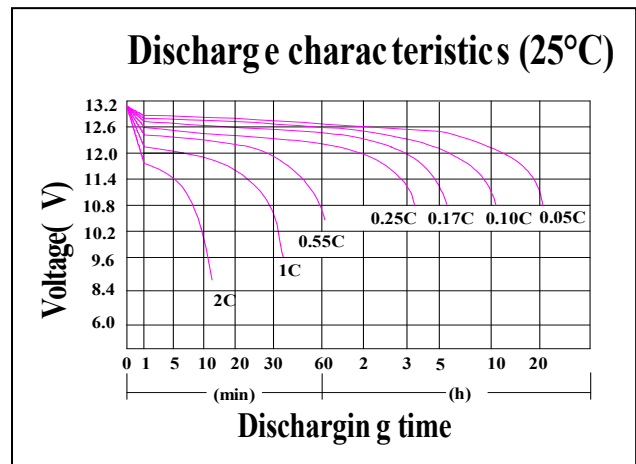
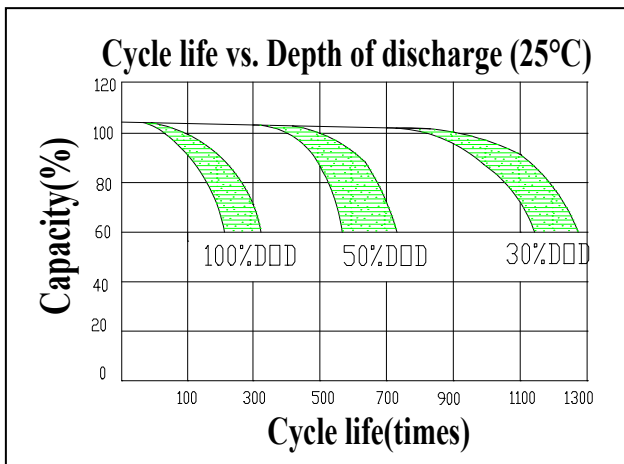
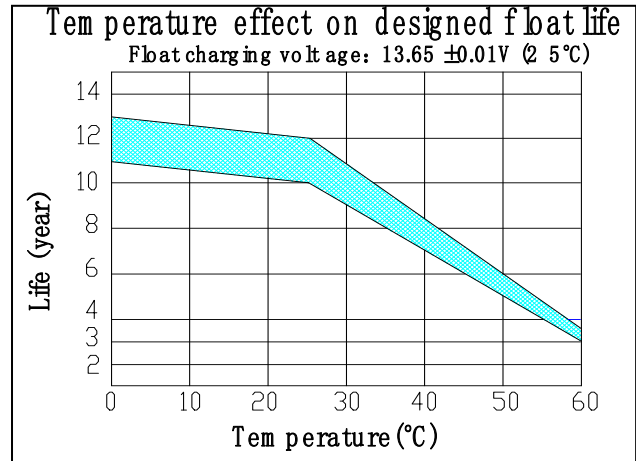
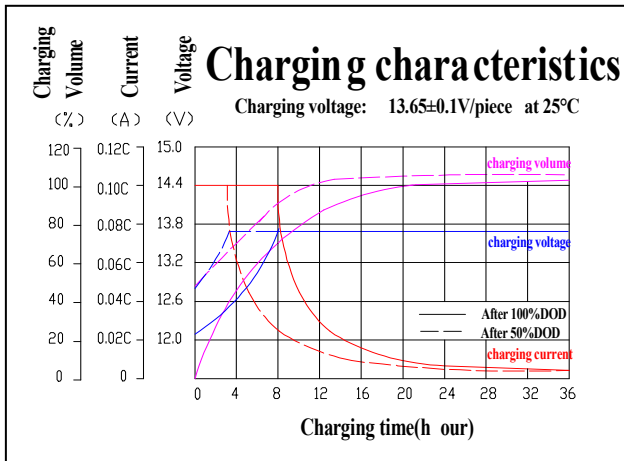

Battery Construction

Component	Positive plate	Negative plate	Container	Cover	Safety valve	Terminal	Separator	Electrolyte
Raw material	Lead dioxide	Lead	ABS	ABS	Si-Rubber	Copper	Fiberglass	Sulfuric acid