

### Product Image

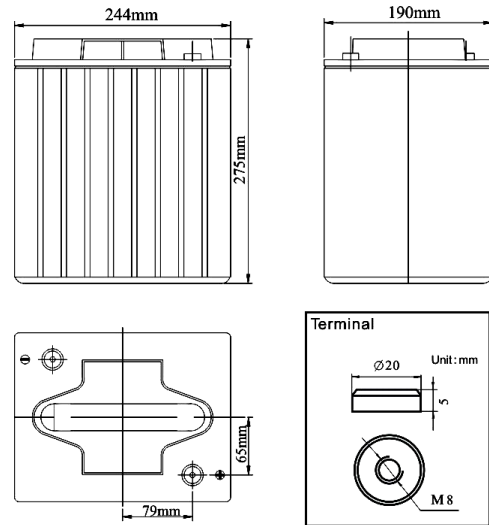

### Product Dimensions



### Characteristics

Nominal Voltage		6V
Nominal Capacity (20 hour rate)		225Ah
Capacity 25°C (77°F)	10 hour rate (20.3A)	203Ah
	5 hour rate (35.8A)	179Ah
	1 hour rate (124.7A)	124.7Ah
Internal Resistance	Full Charged Battery 25°C	≤2.7mΩ
Capacity affected by Temperature (10 hour)	40°C (104°F)	102%
	25°C (77°F)	100%
	0°C (32°F)	85%
	-15°C (5°F)	65%
Self-Discharge 25°C (77°F) Capacity	after 3 month storage	90%
	after 6 month storage	80%
	after 12 month storage	62%
Charge (Constant Voltage) 25°C (77°F)	Float	Initial Charging Current Less than 45A Voltage 6.8-6.9V
	Cycle	Initial Charging Current Less than 45A Voltage 7.2-7.45V

### Packaging

Battery Dimensions	Length	243mm
	Width	187mm
	Height	275mm
	Total Height	275mm
Box Dimensions	Length	258mm
	Width	201mm
	Height	335mm
Quantity Per Box		1 PC per box
Net weight Per Cell		30.5 kg±3%
Net weight Per Box		30.5kg
Gross Weight		31kg

### Discharge Constant Current per Cell (Amperes at 77°F/25°C)

F.V/Time	5min	10min	15min	30min	45min	1h	2h	3h	5h	8h	10h	20h
1.60V	534.6	340.8	289.6	184.9	135.9	124.7	79.5	55.7	37.9	24.9	22.3	12.4
1.65V	524.9	334.6	284.3	181.5	133.4	122.5	78.0	54.7	37.2	24.5	21.9	12.1
1.70V	515.2	328.4	279.0	178.2	130.9	120.2	76.6	53.7	36.5	24.0	21.5	11.9
1.75V	505.4	322.2	273.8	174.8	128.5	117.9	75.2	52.7	35.8	23.6	21.1	11.7
1.80V	486.0	309.8	263.3	168.1	123.5	113.4	72.3	50.6	34.4	22.7	20.3	11.25

### Discharge Constant Power per Cell (Watts at 77°F 25°C)

F.V/Time	5min	10min	15min	30min	45min	1h	2h	3h	5h	8h	10h	20h
1.60V	1029.1	656.1	557.4	355.9	261.6	240.1	153.0	107.2	72.9	48.0	42.9	23.8
1.65V	1010.4	644.1	547.3	349.4	256.8	235.8	150.2	105.2	71.6	47.2	42.1	23.4
1.70V	991.7	632.2	537.2	343.0	252.1	231.4	147.5	103.3	70.2	46.3	41.3	23.0
1.75V	973.0	620.3	527.0	336.5	247.3	227.0	144.7	101.4	68.9	45.4	40.5	22.5
1.80V	935.6	596.4	506.8	323.5	237.8	218.3	139.1	97.5	66.3	43.7	39.0	21.7

**Note** The above data are average values, and can be obtained within 3 charge/discharge cycles. These are not minimum values. Cell and battery designs/specifications are subject to modification without notice. Contact **MCA** for the latest information.

## Performance Characteristics

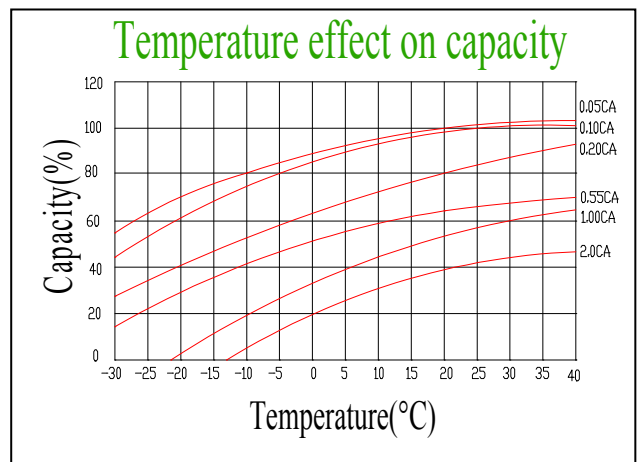
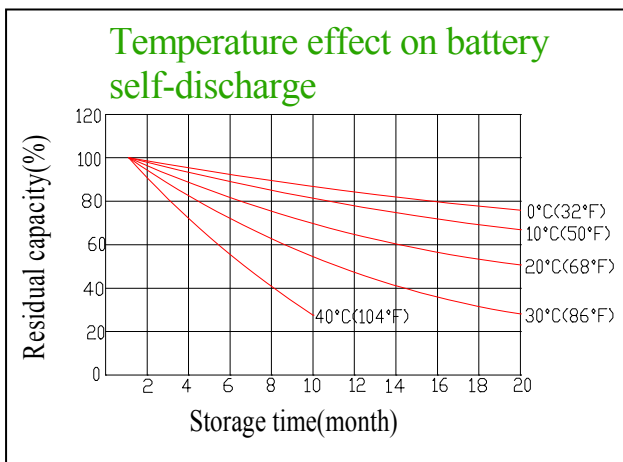
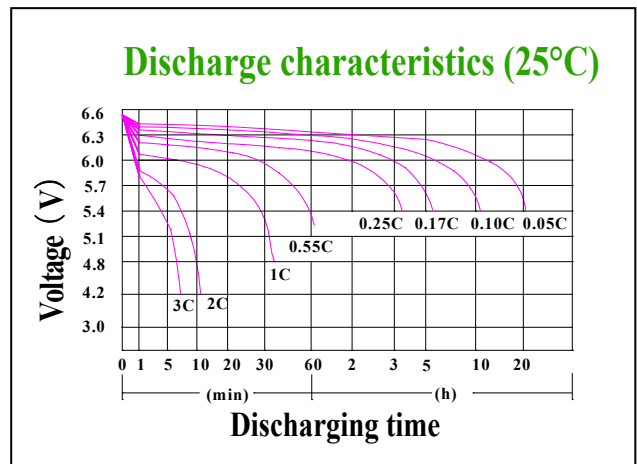
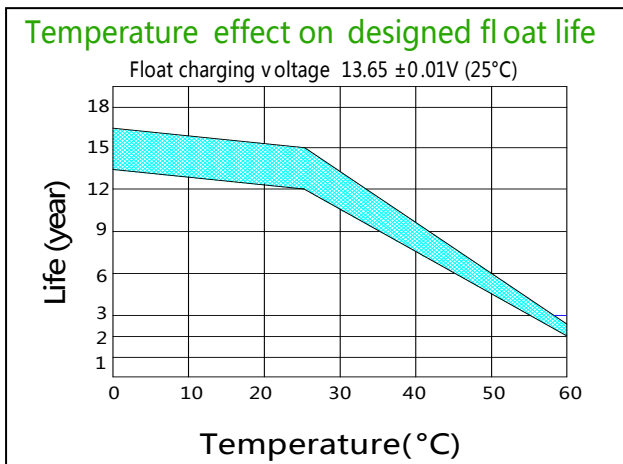
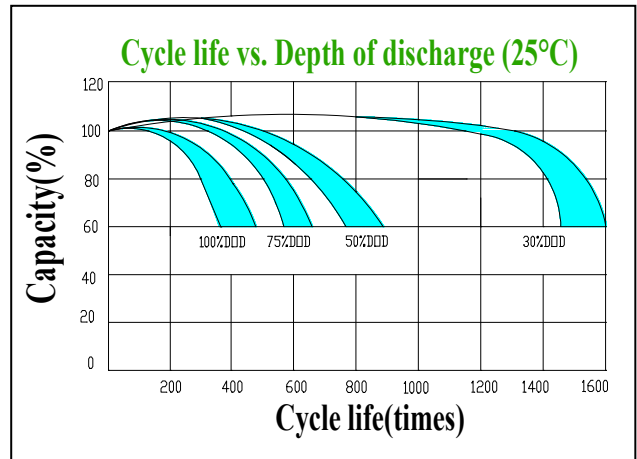
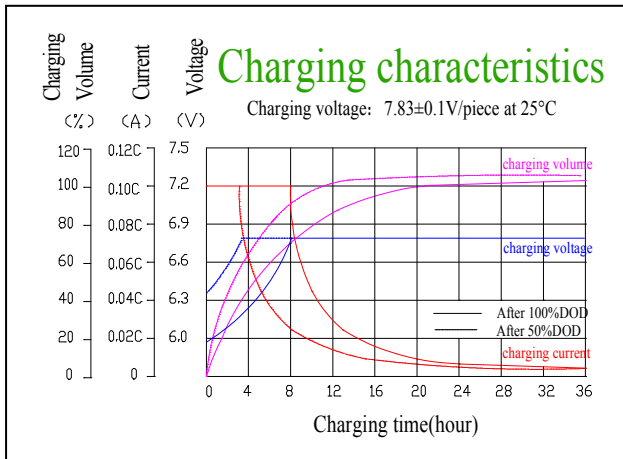

## Battery Construction

Component	Positive plate	Negative plate	Container	Cover	Safety valve	Terminal	Separator	Electrolyte
Raw material	Lead dioxide	Lead	ABS	ABS	Si-Rubber	Copper	Fiberglass	Sulfuric acid