

### Product Image

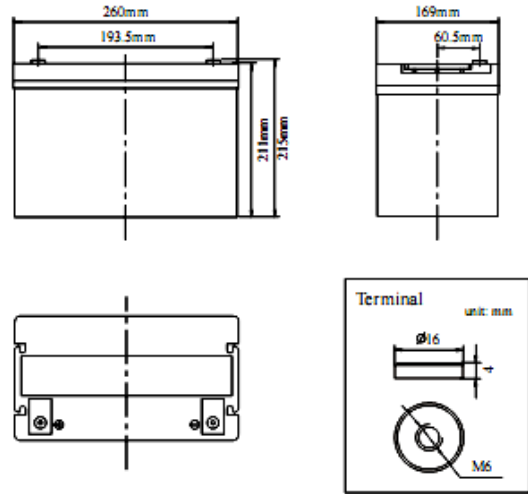

### Product Dimensions



### Characteristics

Nominal Voltage		12V
Nominal Capacity (20 hour rate)		85Ah
Capacity 25°C (77°F)	10 hour rate (7.7A)	77Ah
	5 hour rate (13.5A)	67.5Ah
	1 hour rate (47.1A)	47.1Ah
Internal Resistance	Full Charged Battery 25°C	≤5.5mΩ
Capacity affected by Temperature (10 hour)	40°C (104°F)	102%
	25°C (77°F)	100%
	0°C (32°F)	85%
	-15°C (5°F)	65%
Self-Discharge 25°C (77°F) Capacity	after 3 month storage	90%
	after 6 month storage	80%
	after 12 month storage	62%
Charge (Constant Voltage) 25°C (77°F)	Float	Initial Charging Current Less than 17A Voltage 13.6-13.8V
	Cycle	Initial Charging Current Less than 17A Voltage 14.4-14.9V

### Packaging

Battery Dimensions	Length	260mm
	Width	169mm
	Height	211mm
	Total Height	215mm
Box Dimensions	Length	275mm
	Width	183mm
	Height	272mm
Quantity Per Box		1 PC per box
Net weight Per Cell		26.1 kg±3%
Net weight Per Box		26.1kg
Gross Weight		26.6kg

### Discharge Constant Current (Amperes at 77°F 25°C)

F.V/Time	5min	10min	15min	30min	45min	1h	2h	3h	5h	8h	10h	20h
1.60V	202.0	128.7	109.4	69.8	51.3	47.1	30.0	21.0	14.3	9.4	8.4	4.67
1.65V	198.3	126.4	107.4	68.6	50.4	46.3	29.4	20.7	14.0	9.3	8.3	4.59
1.70V	194.6	124.1	105.4	67.3	49.5	45.4	28.9	20.3	13.8	9.1	8.1	4.5
1.75V	190.9	121.7	103.4	66.0	48.5	44.6	28.3	19.9	13.5	8.9	8.0	4.42
1.80V	183.6	117.0	99.5	63.5	46.7	42.8	27.2	19.1	13.0	8.6	7.7	4.25

### Discharge Constant Power (Watts at 77°F 25°C)

F.V/Time	5min	10min	15min	30min	45min	1h	2h	3h	5h	8h	10h	20h
1.60V	388.8	247.8	210.6	134.5	98.8	90.7	57.7	40.5	27.5	18.1	16.2	9.0
1.65V	381.7	243.3	206.8	132.0	97.0	89.1	56.6	39.8	27.0	17.8	15.9	8.8
1.70V	374.6	238.8	202.9	129.6	95.2	87.4	55.6	39.0	26.5	17.5	15.6	8.7
1.75V	367.6	234.3	199.1	127.1	93.4	85.8	54.5	38.3	26.0	17.2	15.3	8.5
1.80V	353.4	225.3	191.4	122.2	89.8	82.5	52.4	36.8	25.0	16.5	14.7	8.2

**Note** The above data are average values, and can be obtained within 3 charge/discharge cycles. These are not minimum values. Cell and battery designs/specifications are subject to modification without notice. Contact **MCA** for the latest information.

## Performance Characteristics

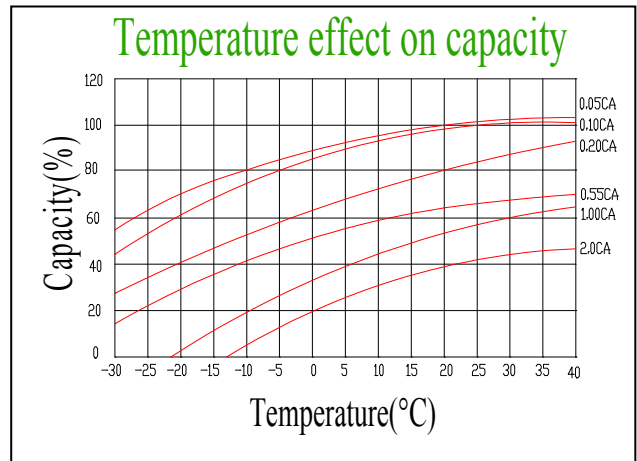
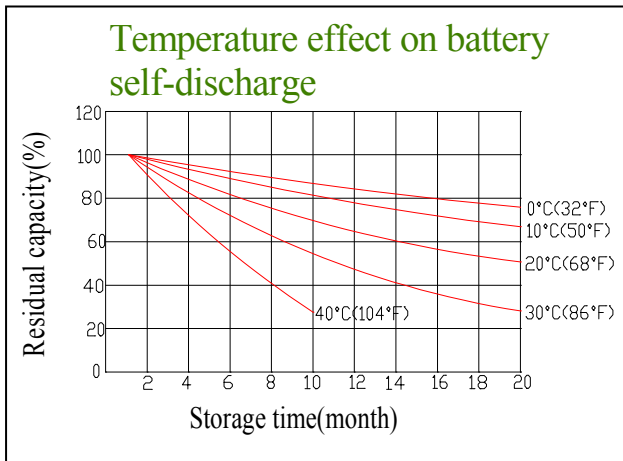
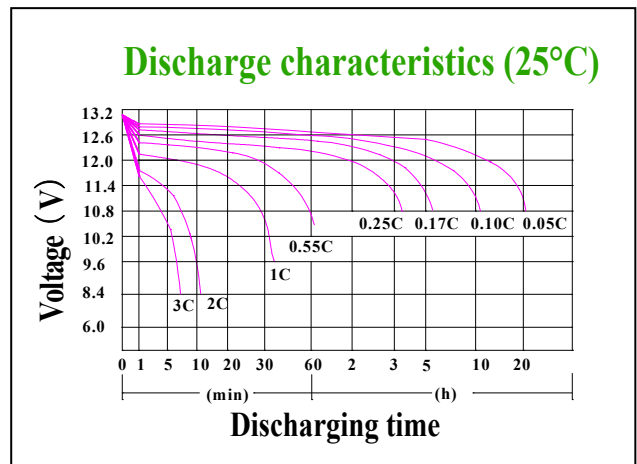
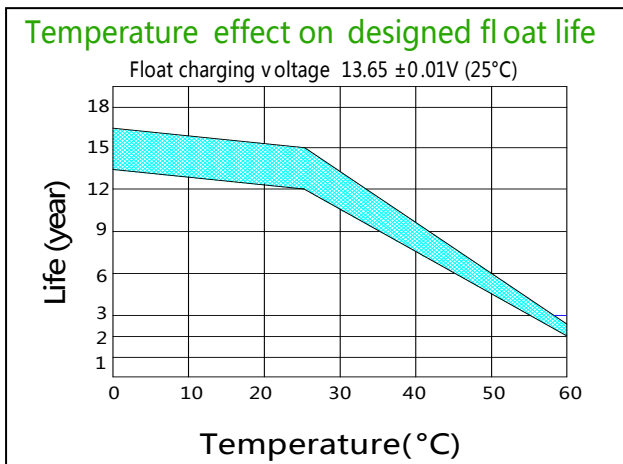
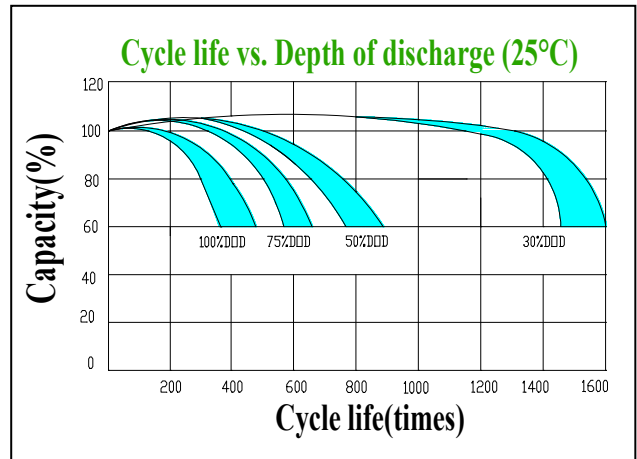
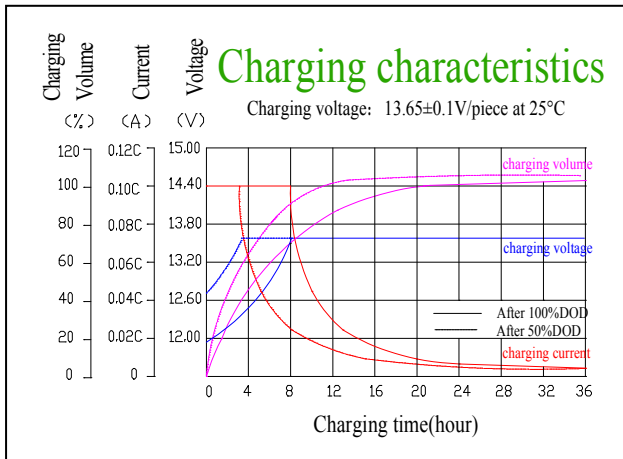

## Battery Construction

Component	Positive plate	Negative plate	Container	Cover	Safety valve	Terminal	Separator	Electrolyte
Raw material	Lead dioxide	Lead	ABS	ABS	Si-Rubber	Copper	Fiberglass	Sulfuric acid