

Product Image

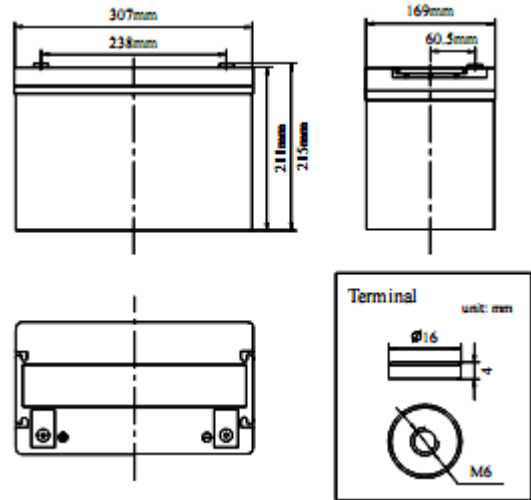

Product Dimensions



Characteristics

Nominal Voltage		12V
Nominal Capacity (20 hour rate)		90Ah
Capacity 25°C (77°F)	10 hour rate (8.1A)	81Ah
	5 hour rate (14.3A)	71.5Ah
	1 hour rate (49.9A)	49.9Ah
Internal Resistance	Full Charged Battery 25°C	≤5.3mΩ
Capacity affected by Temperature (10 hour)	40°C (104°F)	102%
	25°C (77°F)	100%
	0°C (32°F)	85%
	-15°C (5°F)	65%
Self-Discharge 25°C (77°F) Capacity	after 3 month storage	90%
	after 6 month storage	80%
	after 12 month storage	62%
Charge (Constant Voltage) 25°C (77°F)	Float	Initial Charging Current Less than 18A Voltage 13.6-13.8V
	Cycle	Initial Charging Current Less than 18A Voltage 14.4-14.9V

Packaging

Battery Dimensions	Length	307mm
	Width	169mm
	Height	211mm
	Total Height	216mm
Box Dimensions	Length	322mm
	Width	184mm
	Height	251mm
Quantity Per Box		1 PC per box
Net weight Per Cell		28.2 kg±3%
Net weight Per Box		28.2kg
Gross Weight		28.7kg

Discharge Constant Current per Cell (Amperes at 77°F/25°C)

F.V/Time	5min	10min	15min	30min	45min	1h	2h	3h	5h	8h	10h	20h
1.60V	213.8	136.3	115.8	74.0	54.4	49.9	31.7	22.3	15.1	10.0	8.9	4.95
1.65V	210.0	133.8	113.7	72.6	53.4	49.0	31.1	21.9	14.9	9.8	8.7	4.86
1.70V	206.1	131.4	111.6	71.3	52.4	48.1	30.6	21.5	14.6	9.6	8.6	4.77
1.75V	202.2	128.9	109.5	69.9	51.4	47.2	30.0	21.1	14.3	9.4	8.4	4.68
1.80V	194.4	123.9	105.3	67.2	49.4	45.4	28.8	20.3	13.8	9.1	8.1	4.50

Discharge Constant Power per Cell (Watts at 77°F 25°C)

F.V/Time	5min	10min	15min	30min	45min	1h	2h	3h	5h	8h	10h	20h
1.60V	411.6	262.4	223.0	142.4	104.6	96.0	61.1	42.9	29.2	19.2	17.2	9.5
1.65V	404.2	257.7	218.9	139.8	102.7	94.3	60.0	42.1	28.6	18.9	16.8	9.4
1.70V	396.7	252.9	214.9	137.2	100.8	92.6	58.8	41.3	28.1	18.5	16.5	9.2
1.75V	389.2	248.1	210.8	134.6	98.9	90.8	57.7	40.5	27.6	18.2	16.2	9.0
1.80V	374.2	238.6	202.7	129.4	95.1	87.3	55.5	39.0	26.5	17.5	15.6	8.7

Note The above data are average values, and can be obtained within 3 charge/discharge cycles. These are not minimum values. Cell and battery designs/specifications are subject to modification without notice. Contact **MCA** for the latest information.

Performance Characteristics

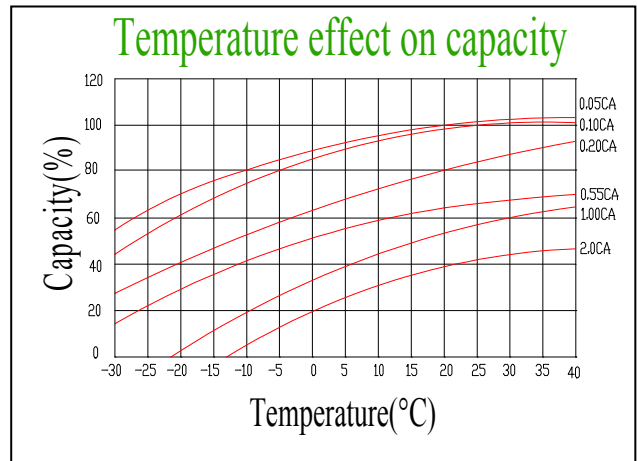
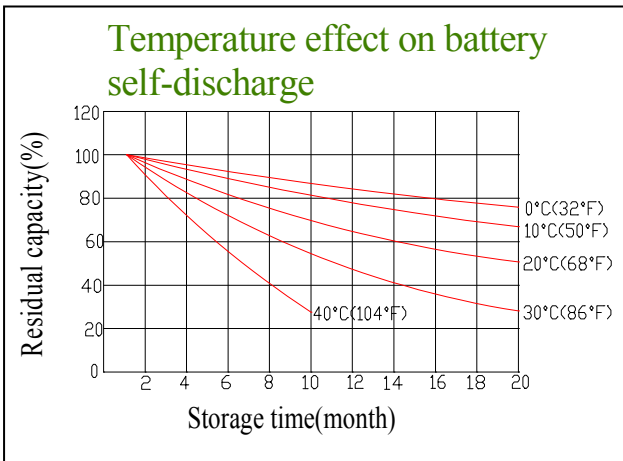
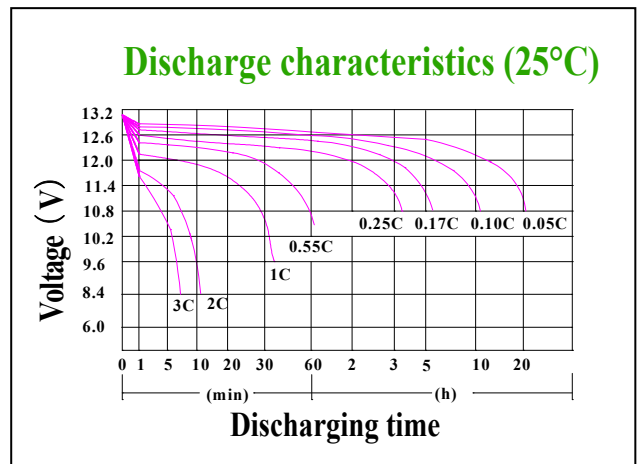
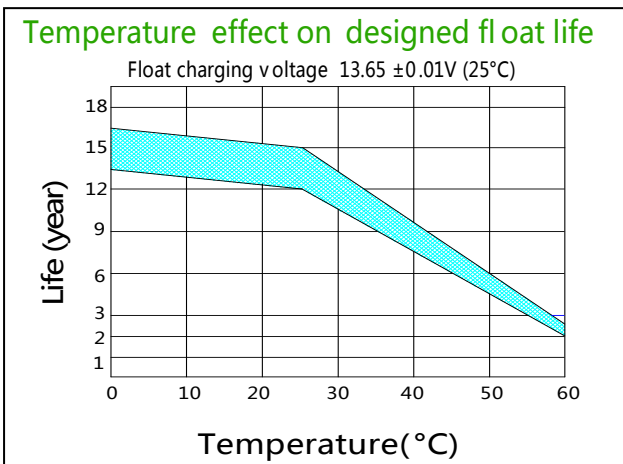
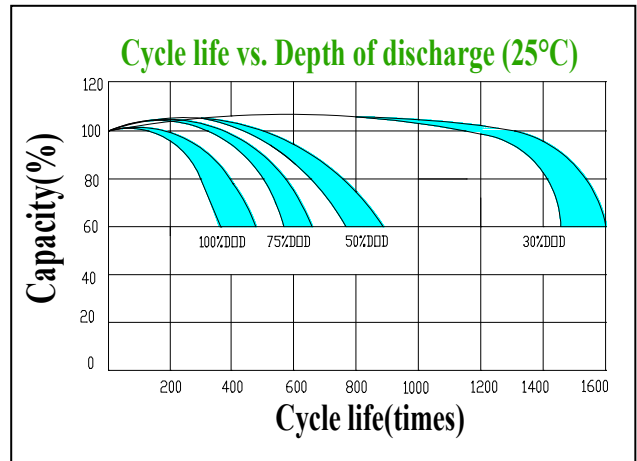
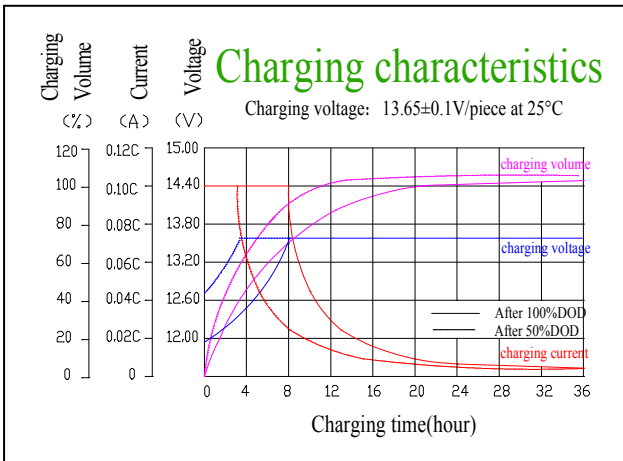

Battery Construction

Component	Positive plate	Negative plate	Container	Cover	Safety valve	Terminal	Separator	Electrolyte
Raw material	Lead dioxide	Lead	ABS	ABS	Si-Rubber	Copper	Fiberglass	Sulfuric acid