

Product Image

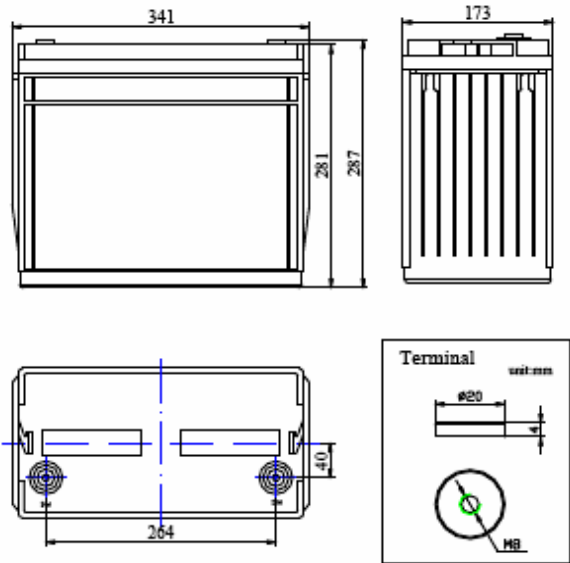

Product Dimensions



Characteristics

Nominal Voltage		12V
Nominal Capacity (20 hour rate)		135Ah
Capacity 25°C (77°F)	10 hour rate (12.2A)	122Ah
	5 hour rate (21.5A)	107.5Ah
	1 hour rate (74.8A)	74.8Ah
Internal Resistance	Full Charged Battery 25°C	≤4.5mΩ
Capacity affected by Temperature (10 hour)	40°C (104°F)	102%
	25°C (77°F)	100%
	0°C (32°F)	85%
	-15°C (5°F)	65%
Self-Discharge 25°C (77°F) Capacity	after 3 month storage	90%
	after 6 month storage	80%
	after 12 month storage	62%
Charge (Constant Voltage) 25°C (77°F)	Float	Initial Charging Current Less than 27A Voltage 13.6-13.8V
	Cycle	Initial Charging Current Less than 27A Voltage 14.4-14.9V

Packaging

Battery Dimensions	Length	341mm
	Width	173mm
	Height	283mm
	Total Height	288mm
Box Dimensions	Length	353mm
	Width	186mm
	Height	345mm
Quantity Per Box		1 PC per box
Net weight Per Cell		40.8 kg±3%
Net weight Per Box		40.8 kg
Gross Weight		41.3 kg

Discharge Constant Current per Cell (Amperes at 77°F 25°C)

F.V/Time	5min	10min	15min	30min	45min	1h	2h	3h	5h	8h	10h	20h
1.60V	320.8	204.5	173.7	110.9	81.5	74.8	47.6	33.4	22.7	15.0	13.4	7.42
1.65V	314.9	200.8	170.6	108.9	80.0	73.5	46.7	32.8	22.3	14.7	13.1	7.29
1.70V	309.1	197.0	167.4	106.9	78.6	72.1	45.8	32.2	21.9	14.4	12.9	7.15
1.75V	303.3	193.3	164.3	104.9	77.1	70.8	45.0	31.6	21.5	14.2	12.6	7.02
1.80V	291.6	185.9	158.0	100.8	74.1	68.0	43.3	30.4	20.7	13.6	12.2	6.75

Discharge Constant Power per Cell (Watts at 77°F 25°C)

F.V/Time	5min	10min	15min	30min	45min	1h	2h	3h	5h	8h	10h	20h
1.60V	617.5	393.6	334.5	213.5	156.9	144.1	91.6	64.3	43.7	28.8	25.7	14.3
1.65V	606.2	386.5	328.4	209.7	154.1	141.5	89.9	63.1	42.9	28.3	25.3	14.0
1.70V	595.0	379.3	322.3	205.8	151.2	138.8	88.3	62.0	42.1	27.8	24.8	13.8
1.75V	583.8	372.2	316.2	201.9	148.4	136.2	86.6	60.8	41.4	27.2	24.3	13.5
1.80V	561.3	357.8	304.1	194.1	142.7	131.0	83.3	58.5	39.8	26.2	23.4	13.0

Note The above data are average values, and can be obtained within 3 charge/discharge cycles. These are not minimum values. Cell and battery designs/specifications are subject to modification without notice. Contact **MCA** for the latest information.

Performance Characteristics

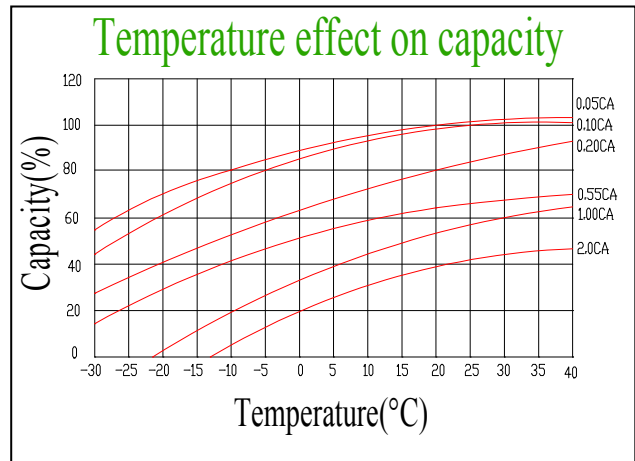
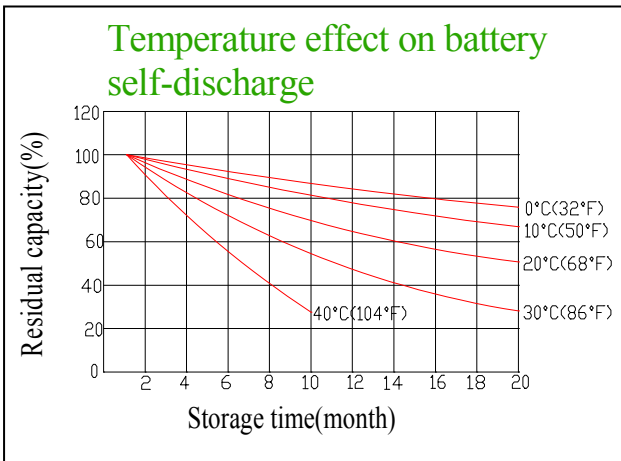
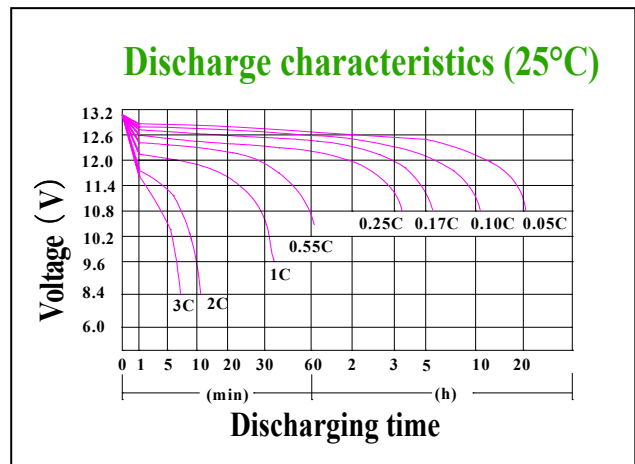
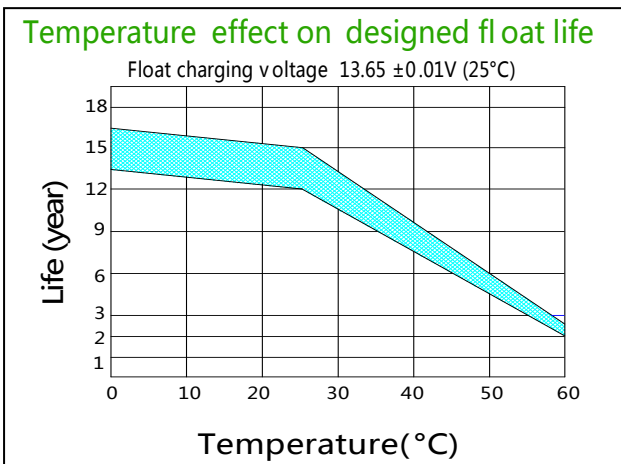
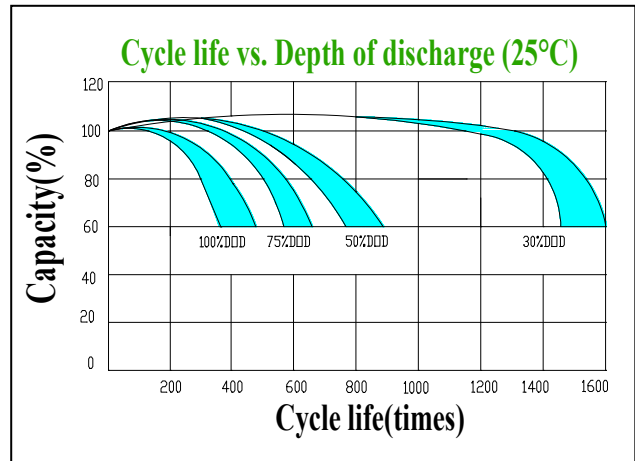
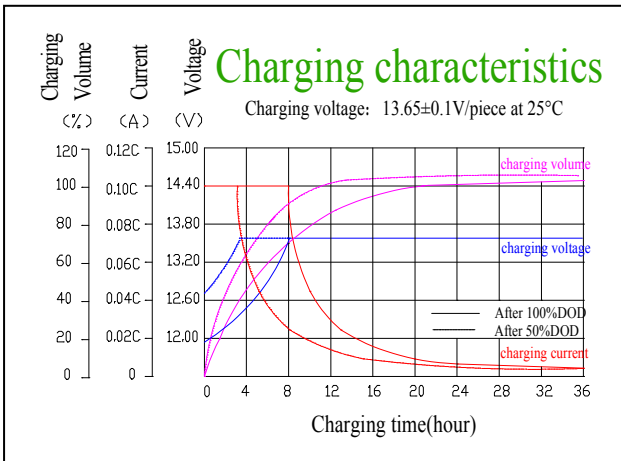

Battery Construction

Component	Positive plate	Negative plate	Container	Cover	Safety valve	Terminal	Separator	Electrolyte
Raw material	Lead dioxide	Lead	ABS	ABS	Si-Rubber	Copper	Fiberglass	Sulfuric acid