

Product Image

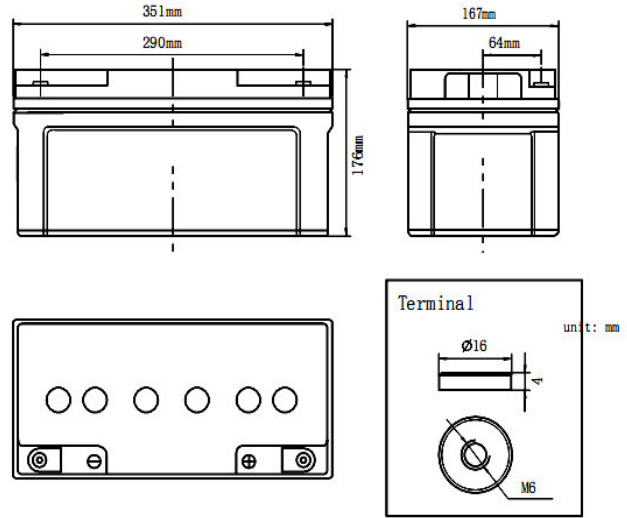

Product Dimensions



Characteristics

Nominal Voltage		12V
Nominal Capacity (10 hour rate)		65Ah
Capacity 25°C (77°F)	20 hour rate (3.61A)	72.2Ah
	5 hour rate (11.9A)	59.5Ah
	1 hour rate (43.2A)	43.2Ah
Internal Resistance	Full Charged Battery 25°C	$\leq 7.0m\Omega$
Capacity affected by Temperature (10 hour)	40°C (104°F)	102%
	25°C (77°F)	100%
	0°C (32°F)	90%
	-15°C (5°F)	70%
Self-Discharge 25°C (77°F) Capacity	after 3 month storage	92%
	after 6 month storage	84%
	after 12 month storage	65%
Charge (Constant Voltage) 25°C (77°F)	Float	Initial Charging Current Less than 16.3A Voltage 13.6-13.8V
	Cycle	Initial Charging Current Less than 16.3A Voltage 14.4-14.9V

Packaging

Battery Dimensions	Length	350mm
	Width	167mm
	Height	178mm
	Total Height	178mm
Box Dimensions	Length	365mm
	Width	181mm
	Height	224mm
Quantity Per Box		1 PC per box
Net weight Per Cell		20.3 kg±3%
Net weight Per Box		20.3kg
Gross Weight		20.8kg

Discharge Constant Current per cell (Amperes at 77°F 25°C)

F.V/Time	5min	10min	15min	30min	45min	1h	2h	3h	5h	8h	10h	20h
1.60V	218.6	145.6	109.7	68.3	49.0	43.2	26.4	19.3	12.4	7.6	6.76	3.75
1.65V	201.5	134.2	105.2	66.5	47.7	42.1	25.9	18.9	12.2	7.5	6.70	3.72
1.70V	204.9	136.5	100.6	64.6	46.4	40.9	25.4	18.6	12.1	7.4	6.63	3.68
1.75V	181.0	120.6	96.0	62.8	45.1	39.8	24.8	18.1	11.9	7.4	6.57	3.64
1.80V	170.8	113.8	91.5	61.0	43.7	38.6	24.2	17.7	11.7	7.3	6.50	3.61

Discharge Constant Power per cell (Watts at 77°F 25°C)

F.V/Time	5min	10min	15min	30min	45min	1h	2h	3h	5h	8h	10h	20h
1.60V	407.6	271.5	204.7	127.4	91.4	80.6	49.2	35.9	23.1	14.1	12.6	7.0
1.65V	375.8	250.3	196.1	123.9	88.9	78.5	48.3	35.3	22.8	14.0	12.5	6.9
1.70V	382.1	254.6	187.6	120.5	86.5	76.3	47.4	34.6	22.5	13.8	12.4	6.9
1.75V	337.6	224.9	179.1	117.1	84.0	74.2	46.2	33.8	22.1	13.7	12.2	6.8
1.80V	318.5	212.1	170.6	113.7	81.6	72.0	45.1	33.0	21.8	13.6	12.1	6.7

Note The above data are average values, and can be obtained within 3 charge/discharge cycles. These are not minimum values. Cell and battery designs/specifications are subject to modification without notice. Contact **MCA** for the latest information.

Performance Characteristics

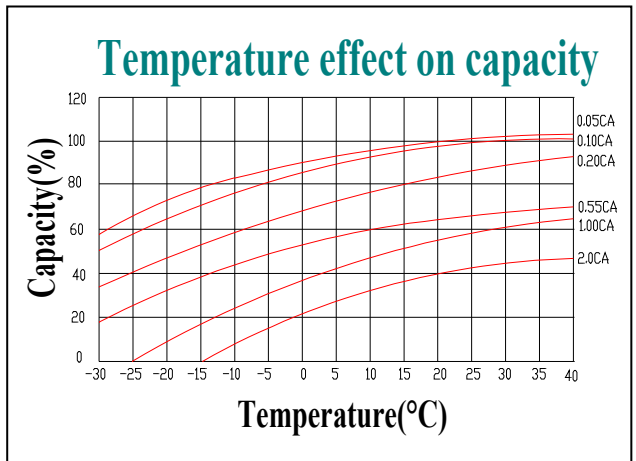
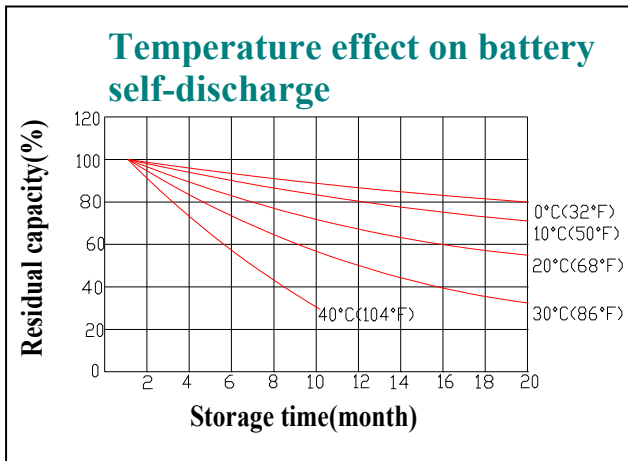
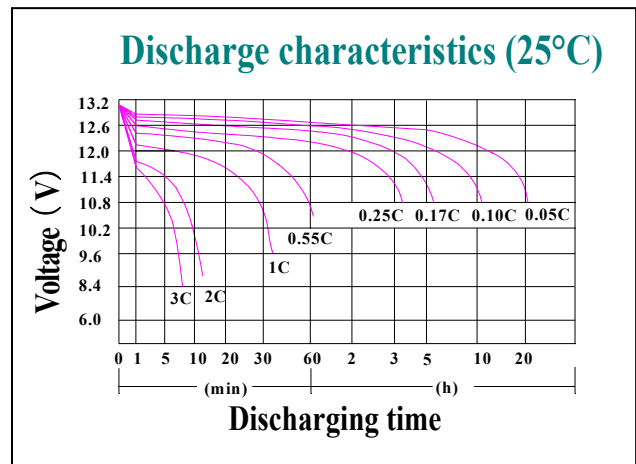
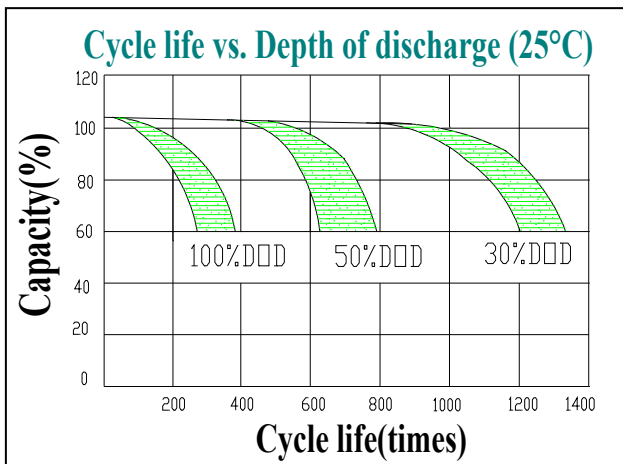
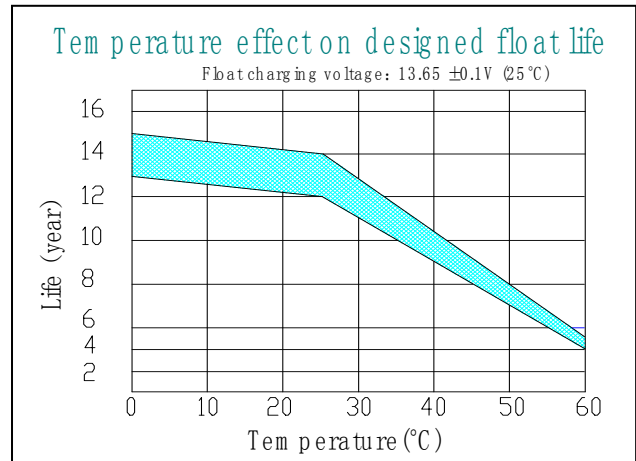
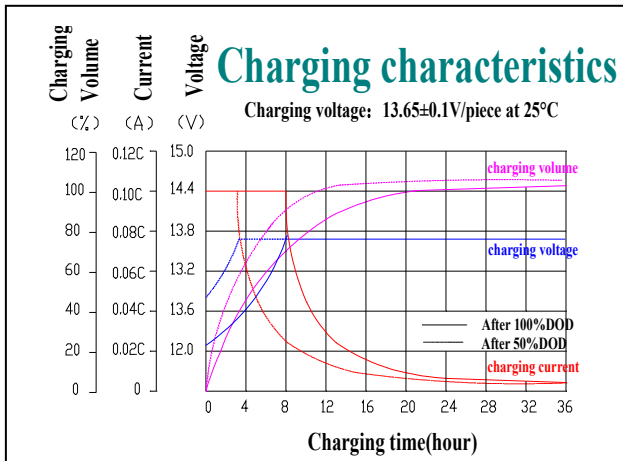

Battery Construction

Component	Positive plate	Negative plate	Container	Cover	Safety valve	Terminal	Separator	Electrolyte
Raw material	Lead dioxide	Lead	ABS	ABS	Si-Rubber	Copper	Fiberglass	GEL