

## Product Image

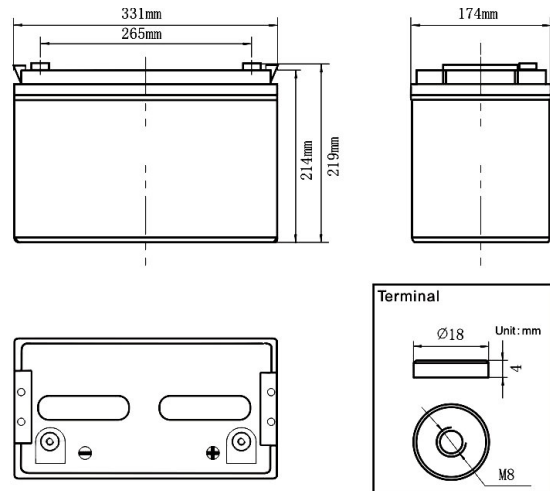

## Product Dimensions



## Characteristics

Nominal Voltage		12V
Nominal Capacity (10 hour rate)		80Ah
Capacity 25°C (77°F)	20 hour rate (4.4A)	88Ah
	5 hour rate (14.1A)	70.5Ah
	1 hour rate (47.5A)	47.5Ah
Internal Resistance	Full Charged Battery 25°C	≤6.0mΩ
Capacity affected by Temperature (10 hour)	40°C (104°F)	102%
	25°C (77°F)	100%
	0°C (32°F)	90%
	-15°C (5°F)	70%
Self-Discharge 25°C (77°F) Capacity	after 3 month storage	92%
	after 6 month storage	84%
	after 12 month storage	65%
Charge (Constant Voltage) 25°C (77°F)	Float	Initial Charging Current Less than 20.0A Voltage 13.6-13.8V
	Cycle	Initial Charging Current Less than 20.0A Voltage 14.4-14.9V

## Packaging

Battery Dimensions	Length	331mm
	Width	174mm
	Height	214mm
	Total Height	219mm
Box Dimensions	Length	346mm
	Width	188mm
	Height	289mm
Quantity Per Box		1 PC per box
Net weight Per Cell		25.0 kg±3%
Net weight Per Box		25.0kg
Gross Weight		25.5kg

### Discharge Constant Current per cell (Amperes at 77°F 25°C)

F.V/Time	15min	30min	45min	1h	2h	3h	5h	8h	10h	20h
1.60V	105.6	77.4	54.6	47.5	32.1	22.0	15.0	9.9	8.8	4.8
1.65V	103.7	76.0	53.6	46.7	31.5	21.6	14.7	9.7	8.6	4.8
1.70V	101.8	74.6	52.6	45.8	31.0	21.2	14.4	9.5	8.5	4.7
1.75V	99.8	73.2	51.6	44.9	30.4	20.8	14.1	9.3	8.3	4.6
1.80V	96.0	70.4	49.6	43.2	29.2	20.0	13.6	9.0	8.0	4.4

### Discharge Constant Power per cell (Watts at 77°F 25°C)

F.V/Time	15min	30min	45min	1h	2h	3h	5h	8h	10h	20h
1.60V	203.3	149.1	105.0	91.5	61.8	42.4	28.8	19.0	16.9	9.3
1.65V	199.6	146.4	103.1	89.8	60.7	41.6	28.3	18.6	16.6	9.1
1.70V	195.9	143.7	101.2	88.1	59.6	40.8	27.8	18.3	16.3	9.0
1.75V	192.2	140.9	99.3	86.5	58.5	40.0	27.2	17.9	16.0	8.8
1.80V	184.8	135.5	95.5	83.2	56.2	38.5	26.2	17.2	15.4	8.5

**Note** The above data are average values, and can be obtained within 3 charge/discharge cycles. These are not minimum values. Cell and battery designs/specifications are subject to modification without notice. Contact **MCA** for the latest information.

## Performance Characteristics

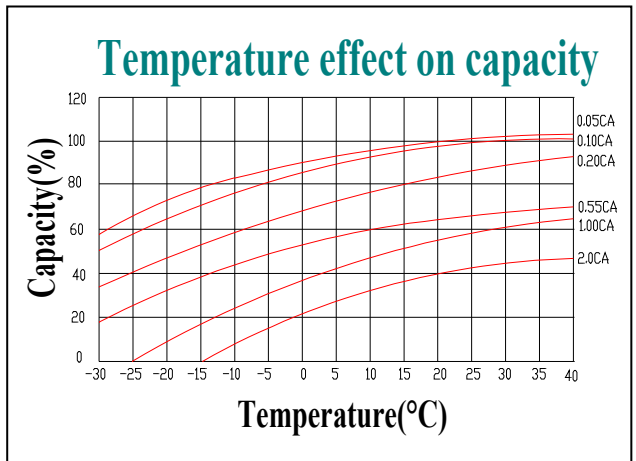
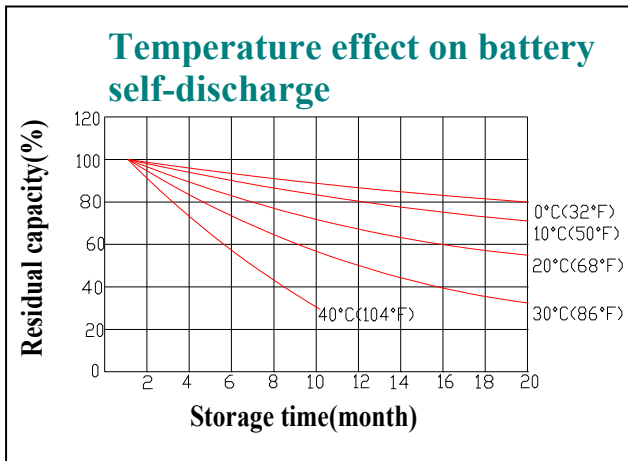
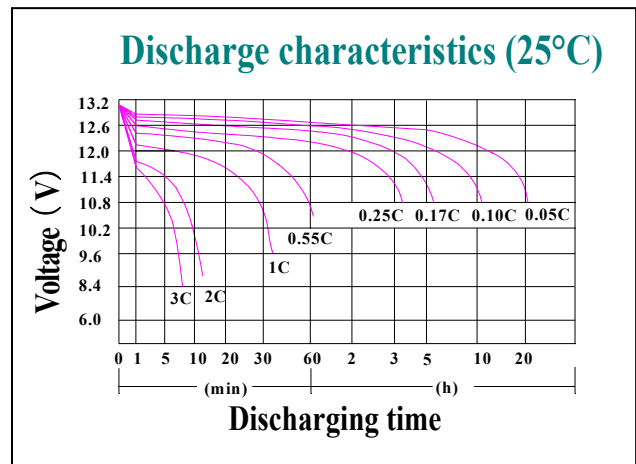
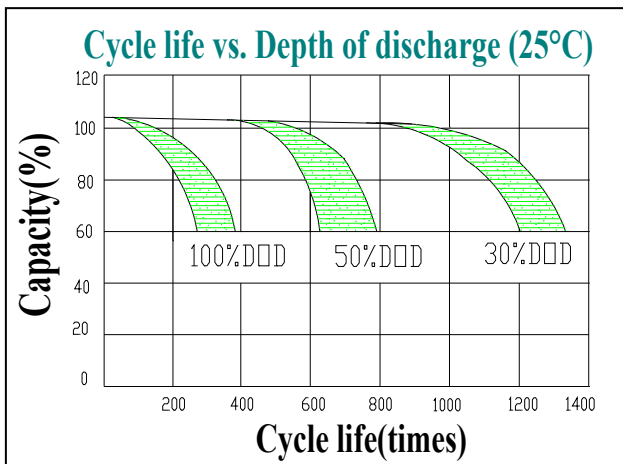
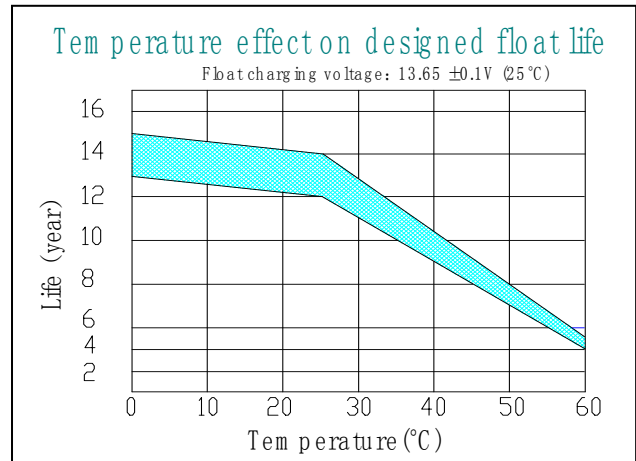
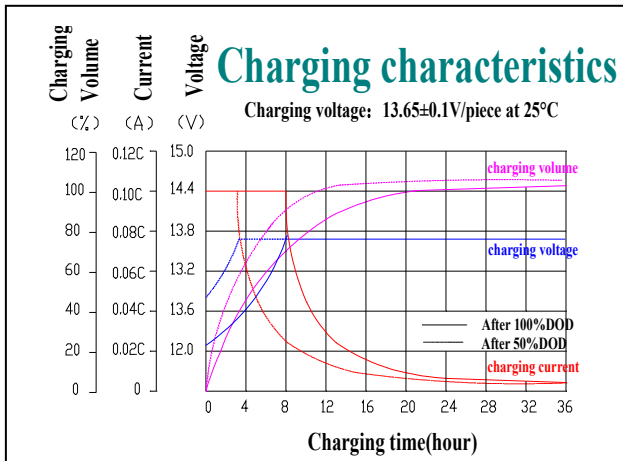

## Battery Construction

Component	Positive plate	Negative plate	Container	Cover	Safety valve	Terminal	Separator	Electrolyte
Raw material	Lead dioxide	Lead	ABS	ABS	Si-Rubber	Copper	Fiberglass	GEL