

Product Image

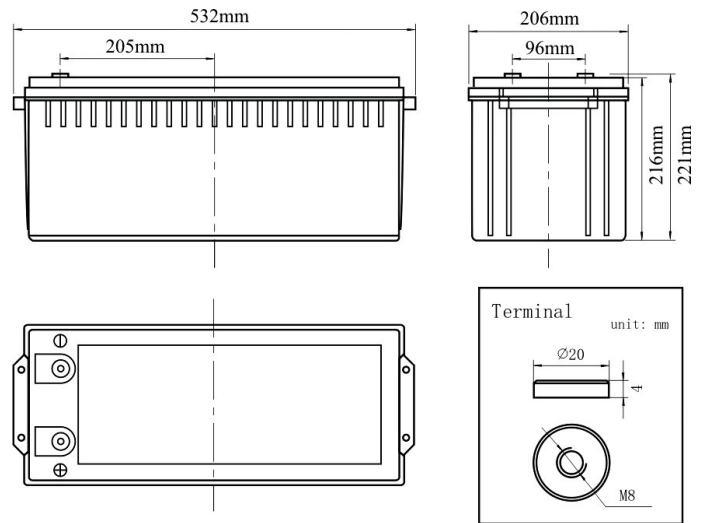

Product Dimensions



Characteristics

Nominal Voltage		12V
Nominal Capacity (20 hour rate)		145Ah
Capacity 25°C (77°F)	10 hour rate (13.7A)	137Ah
	5 hour rate (25.0A)	125Ah
	1 hour rate (82.9A)	82.9Ah
Internal Resistance	Full Charged Battery 25°C	≤3.5mΩ
Capacity affected by Temperature (10 hour)	40°C (104°F)	102%
	25°C (77°F)	100%
	0°C (32°F)	85%
	-15°C (5°F)	65%
Self-Discharge 25°C (77°F) Capacity	after 3 month storage	90%
	after 6 month storage	80%
	after 12 month storage	62%
Charge (Constant Voltage) 25°C (77°F)	Float	Initial Charging Current Less than 32A Voltage 13.6-13.8V
	Cycle	Initial Charging Current Less than 32A Voltage 14.4-14.9V

Packaging

Battery Dimensions	Length	532mm
	Width	206mm
	Height	216mm
	Total Height	221mm
Box Dimensions	Length	547mm
	Width	220mm
	Height	296mm
Quantity Per Box		1 PC per box
Net weight Per Cell		41.6kg±3%
Net weight Per Box		41.6kg
Gross Weight		42.2kg

Discharge Constant Current per Cell (Amperes at 77°F 25°C)

F.V/Time	15min	30min	45min	1h	2h	3h	5h	8h	10h	20h
1.60V	231.3	130.7	93.8	82.9	55.6	40.6	26.1	16.0	14.2	7.55
1.65V	221.7	127.2	91.2	80.6	54.5	39.9	25.8	15.8	14.1	7.48
1.70V	212.0	123.7	88.7	78.4	53.5	39.1	25.4	15.7	14.0	7.41
1.75V	202.4	120.2	86.2	76.2	52.2	38.2	25.0	15.5	13.8	7.33
1.80V	192.8	116.7	83.7	74.0	51.0	37.3	24.7	15.3	13.7	7.26

Discharge Constant Power per Cell (Watts at 77°F 25°C)

F.V/Time	15min	30min	45min	1h	2h	3h	5h	8h	10h	20h
1.60V	445.3	251.7	180.5	159.5	106.9	78.2	50.3	30.7	27.4	14.5
1.65V	426.7	244.9	175.6	155.2	105.0	76.8	49.6	30.4	27.2	14.4
1.70V	408.2	238.2	170.8	151.0	103.0	75.3	48.9	30.1	26.9	14.3
1.75V	389.6	231.4	166.0	146.7	100.6	73.5	48.2	29.8	26.6	14.1
1.80V	371.1	224.7	161.1	142.4	98.1	71.7	47.5	29.5	26.4	14.0

Note The above data are average values, and can be obtained within 3 charge/discharge cycles. These are not minimum values. Cell and battery designs/specifications are subject to modification without notice. Contact **MCA** for the latest information.

Performance Characteristics

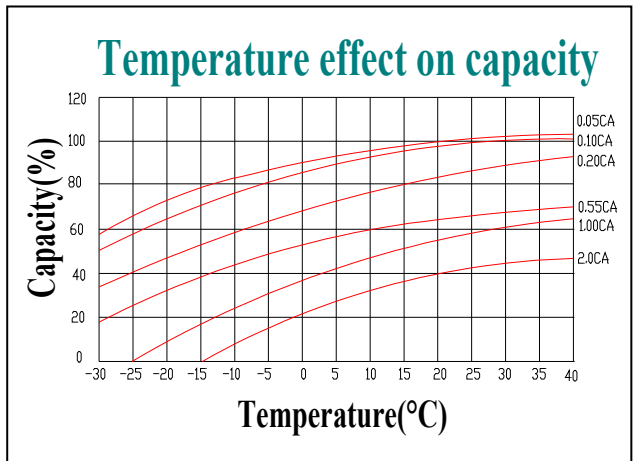
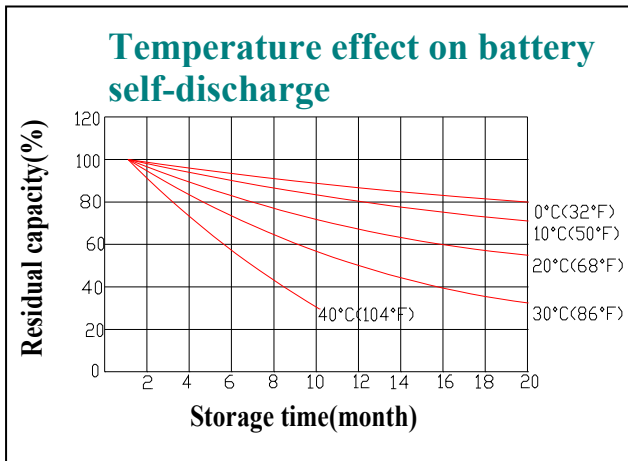
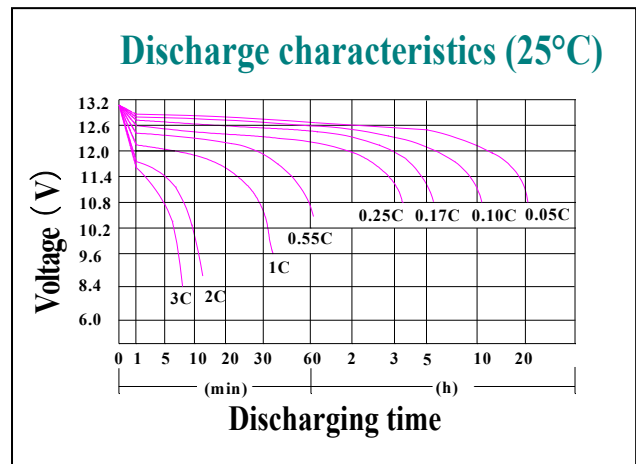
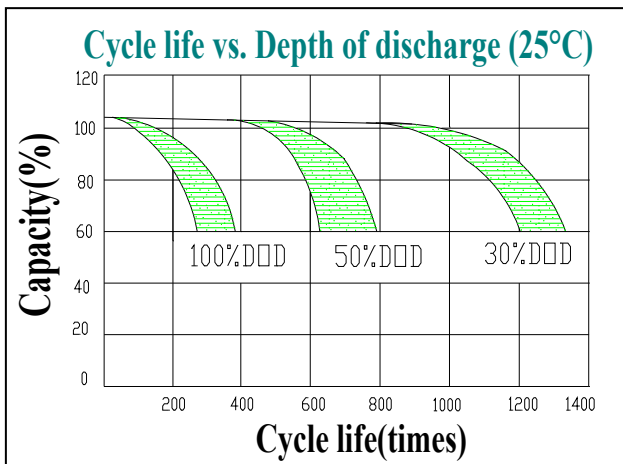
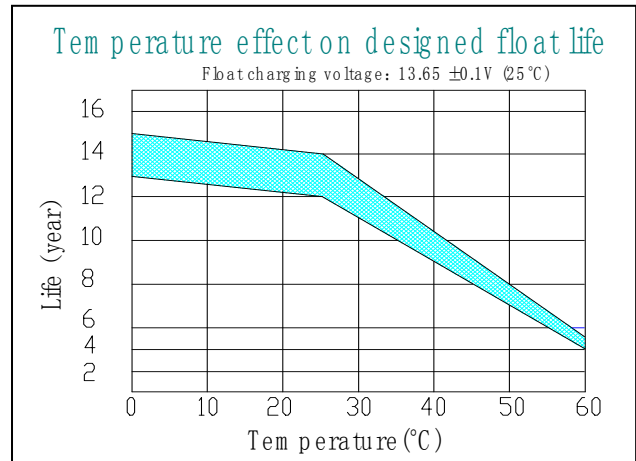
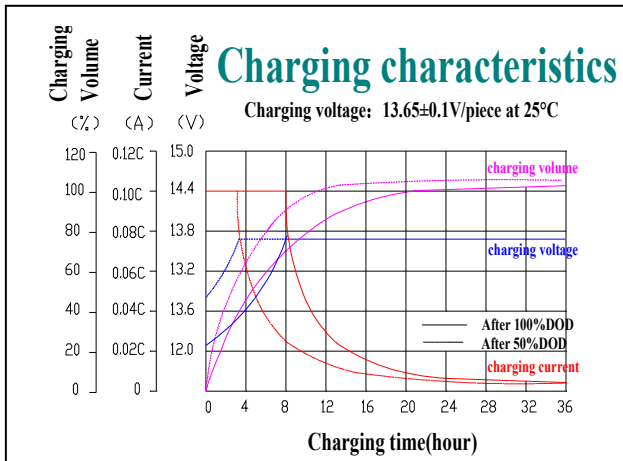

Battery Construction

Component	Positive plate	Negative plate	Container	Cover	Safety valve	Terminal	Separator	Electrolyte
Raw material	Lead dioxide	Lead	ABS	ABS	Si-Rubber	Copper	Fiberglass	GEL