

Product Image

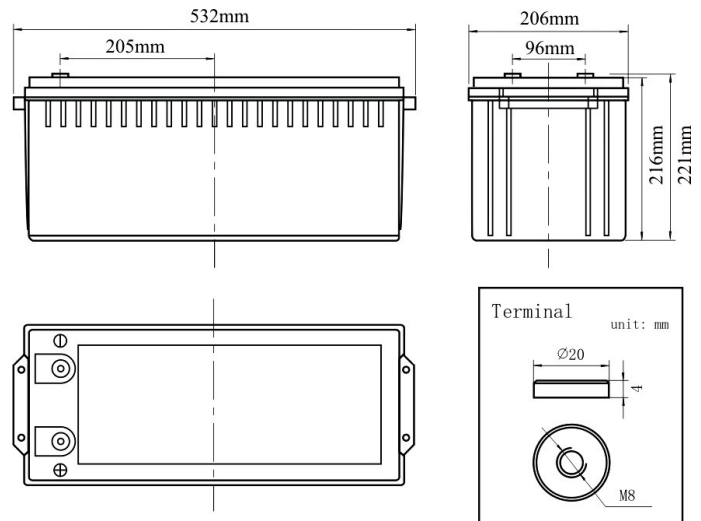

Product Dimensions



Characteristics

Nominal Voltage		12V
Nominal Capacity (10 hour rate)		160Ah
Capacity 25°C (77°F)	20 hour rate (8.88A)	176.7Ah
	5 hour rate (29.2A)	146Ah
	1 hour rate (106.4A)	106.4Ah
Internal Resistance	Full Charged Battery 25°C	≤3.2mΩ
Capacity affected by Temperature (10 hour)	40°C (104°F)	102%
	25°C (77°F)	100%
	0°C (32°F)	90%
	-15°C (5°F)	70%
Self-Discharge 25°C (77°F) Capacity	after 3 month storage	92%
	after 6 month storage	84%
	after 12 month storage	65%
Charge (Constant Voltage) 25°C (77°F)	Float	Initial Charging Current Less than 32A Voltage 13.6-13.8V
	Cycle	Initial Charging Current Less than 32A Voltage 14.4-14.9V

Packaging

Battery Dimensions	Length	532mm
	Width	206mm
	Height	216mm
	Total Height	221mm
Box Dimensions	Length	547mm
	Width	220mm
	Height	296mm
Quantity Per Box		1 PC per box
Net weight Per Cell		48.5kg±3%
Net weight Per Box		48.5kg
Gross Weight		49.3kg

Discharge Constant Current per cell (Amperes at 77°F 25°C)

F.V/Time	5min	10min	15min	30min	45min	1h	2h	3h	5h	8h	10h	20h
1.60V	538.0	358.4	270.1	168.1	120.6	106.4	64.9	47.4	30.5	18.6	16.64	9.24
1.65V	496.0	330.4	258.9	163.6	117.4	103.6	63.7	46.6	30.1	18.5	16.48	9.15
1.70V	504.4	336.0	247.6	159.1	114.1	100.7	62.5	45.7	29.7	18.3	16.32	9.06
1.75V	445.5	296.8	236.4	154.6	110.9	97.9	61.0	44.6	29.2	18.1	16.16	8.97
1.80V	420.3	280.0	225.1	150.1	107.7	95.0	59.5	43.5	28.8	17.9	16.00	8.88

Discharge Constant Power per cell (Watts at 77°F 25°C)

F.V/Time	5min	10min	15min	30min	45min	1h	2h	3h	5h	8h	10h	20h
1.60V	1003.4	668.4	503.8	313.5	224.9	198.5	121.0	88.5	56.9	34.8	31.0	17.2
1.65V	925.0	616.2	482.8	305.1	218.9	193.2	118.8	86.8	56.1	34.4	30.7	17.1
1.70V	940.7	626.6	461.8	296.7	212.9	187.9	116.6	85.2	55.3	34.1	30.4	16.9
1.75V	830.9	553.5	440.8	288.3	206.8	182.6	113.8	83.2	54.5	33.8	30.1	16.7
1.80V	783.9	522.2	419.8	279.9	200.8	177.2	111.0	81.2	53.7	33.4	29.8	16.6

Note The above data are average values, and can be obtained within 3 charge/discharge cycles. These are not minimum values. Cell and battery designs/specifications are subject to modification without notice. Contact **MCA** for the latest information.

Performance Characteristics

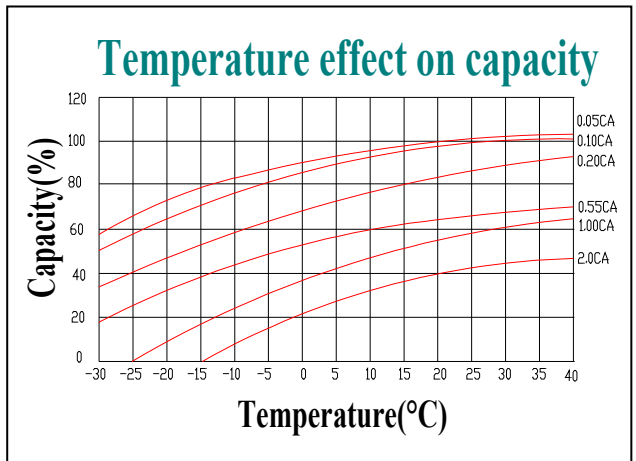
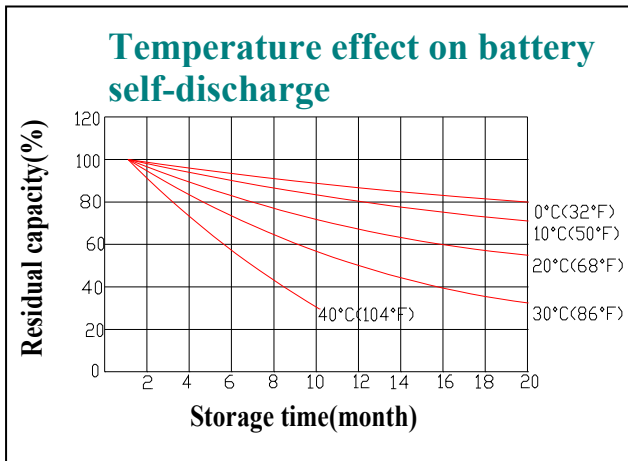
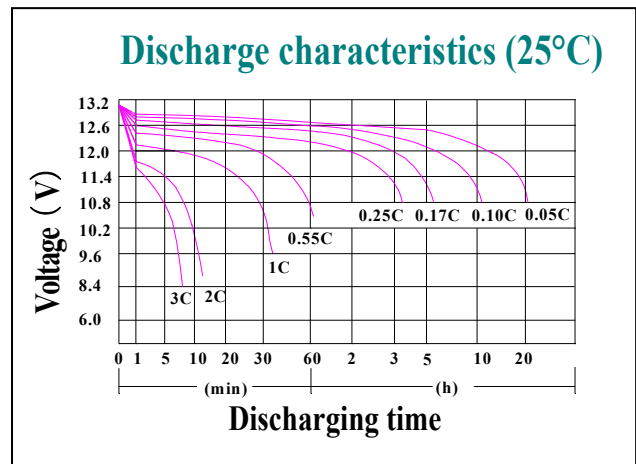
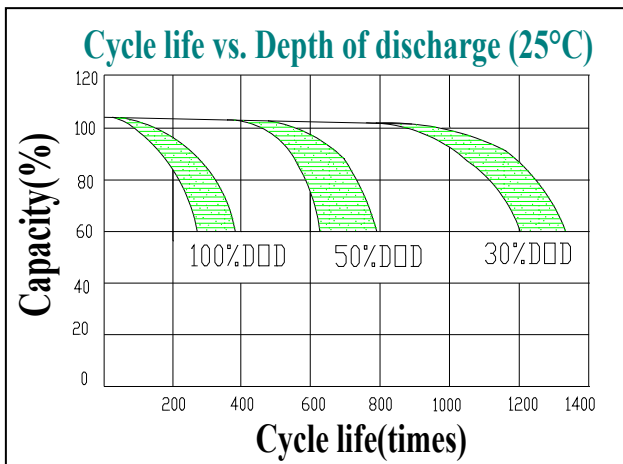
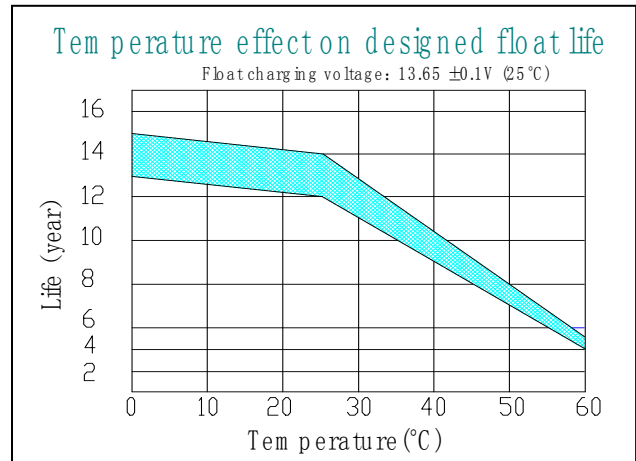
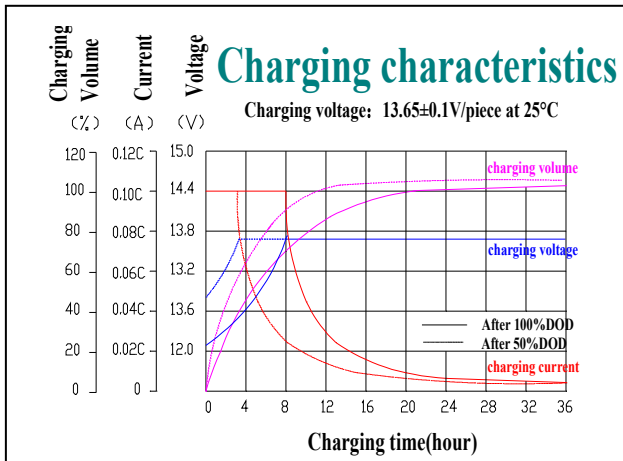

Battery Construction

Component	Positive plate	Negative plate	Container	Cover	Safety valve	Terminal	Separator	Electrolyte
Raw material	Lead dioxide	Lead	ABS	ABS	Si-Rubber	Copper	Fiberglass	GEL